

$$+ ab^2$$

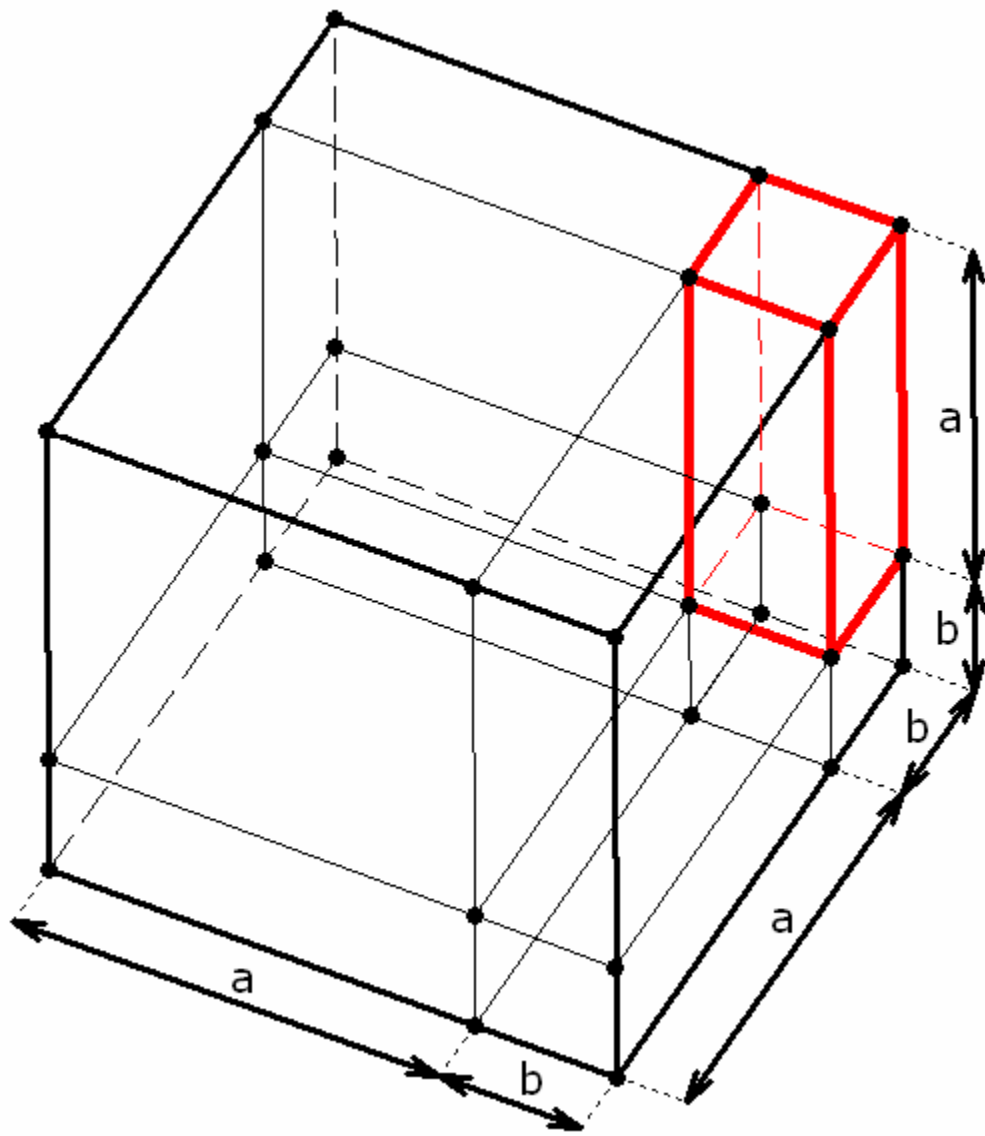

$$+ ab^2$$

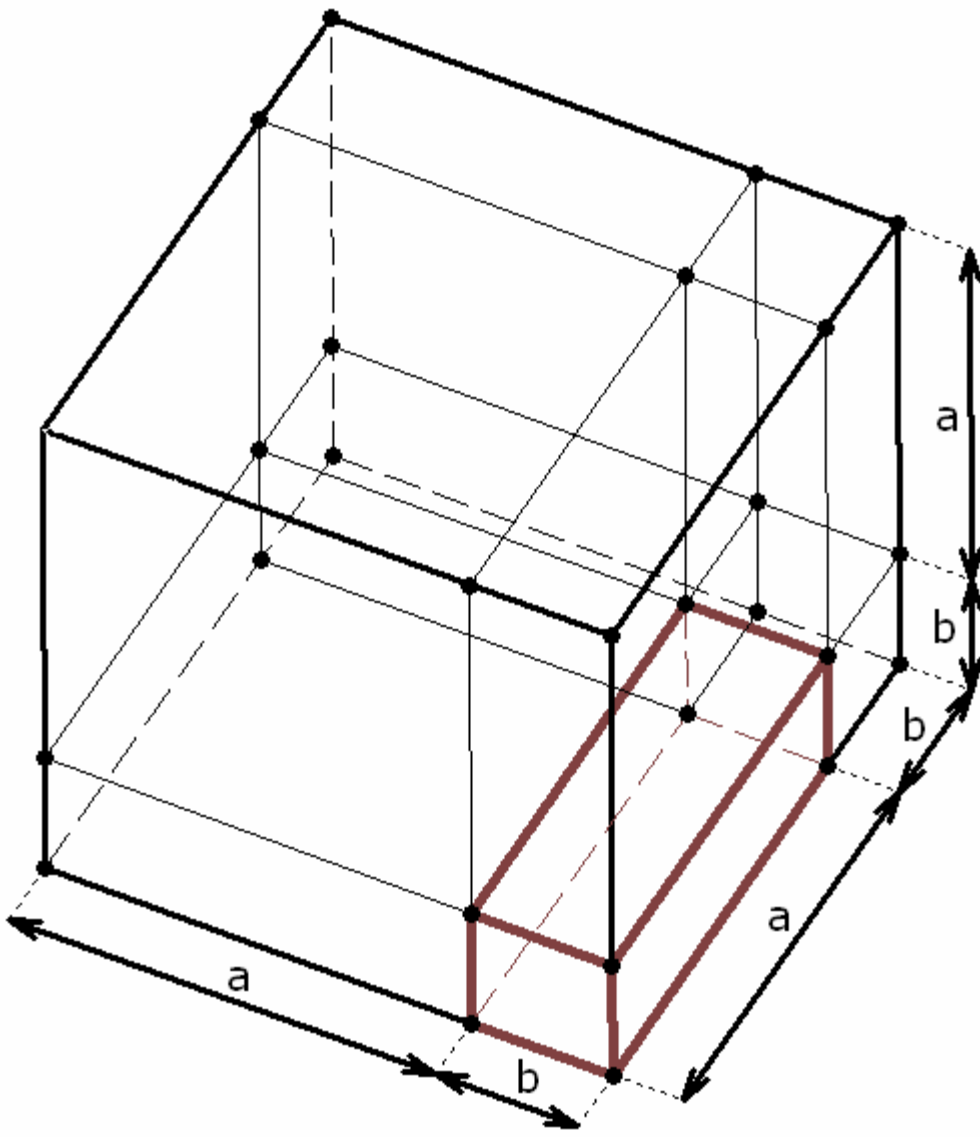

$$+ ab^2$$

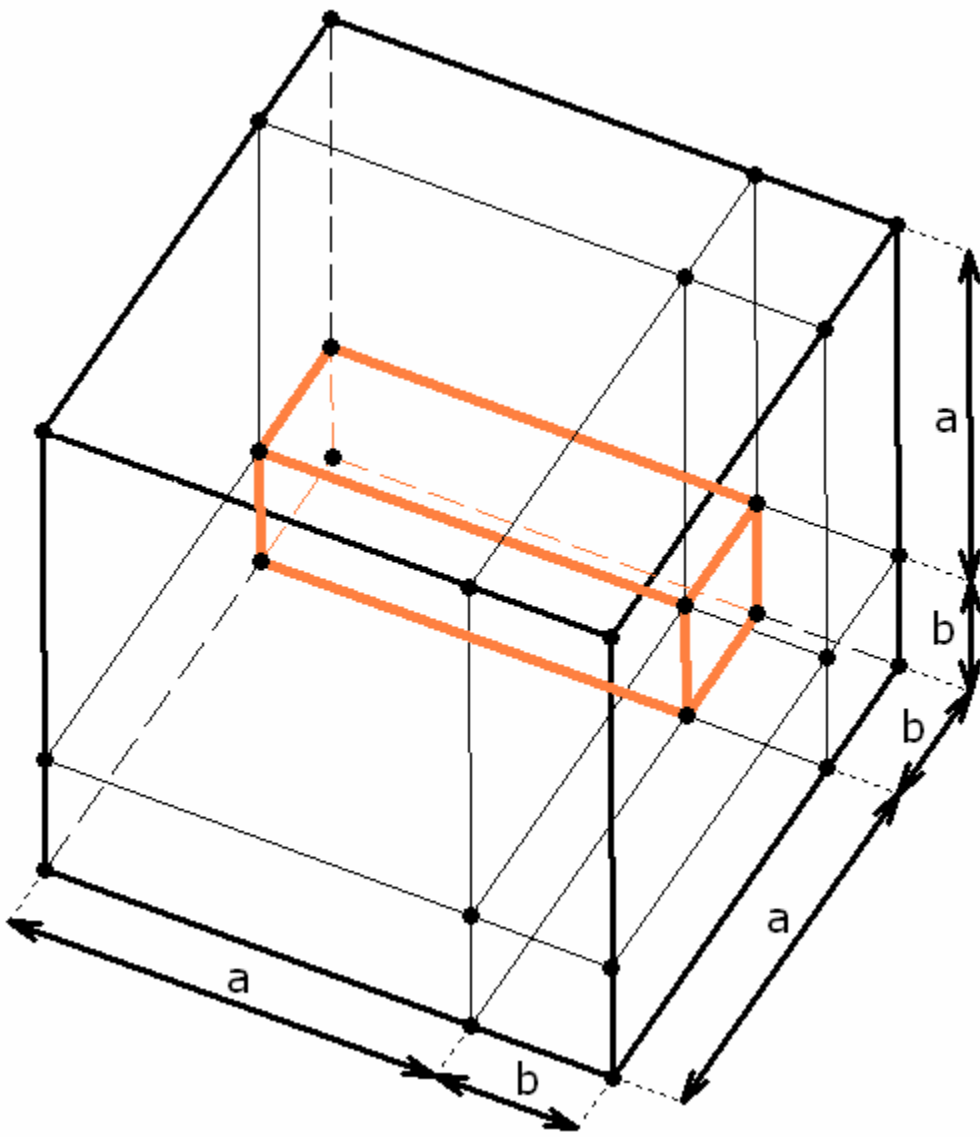

$$+ a^2 b$$

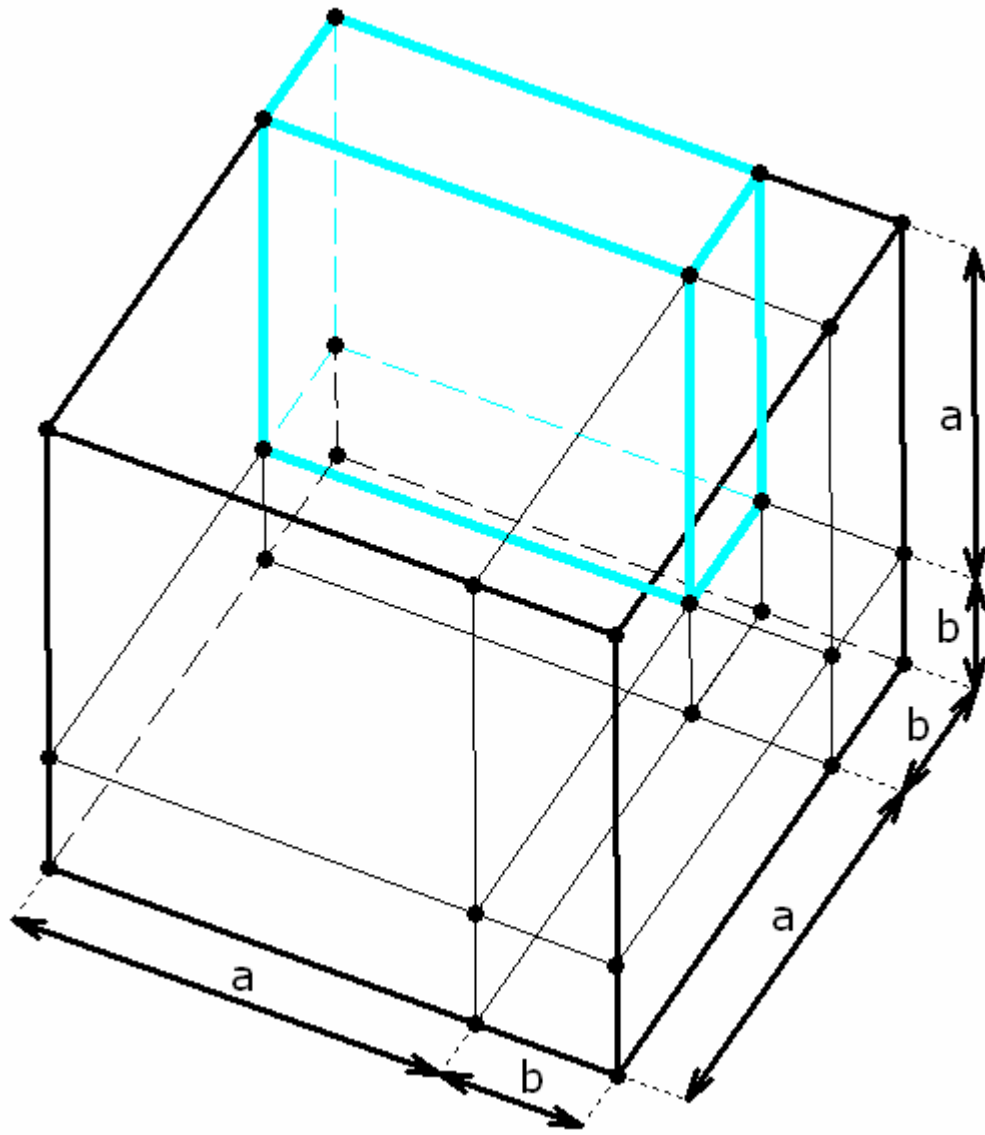

$$+ a^2 b$$

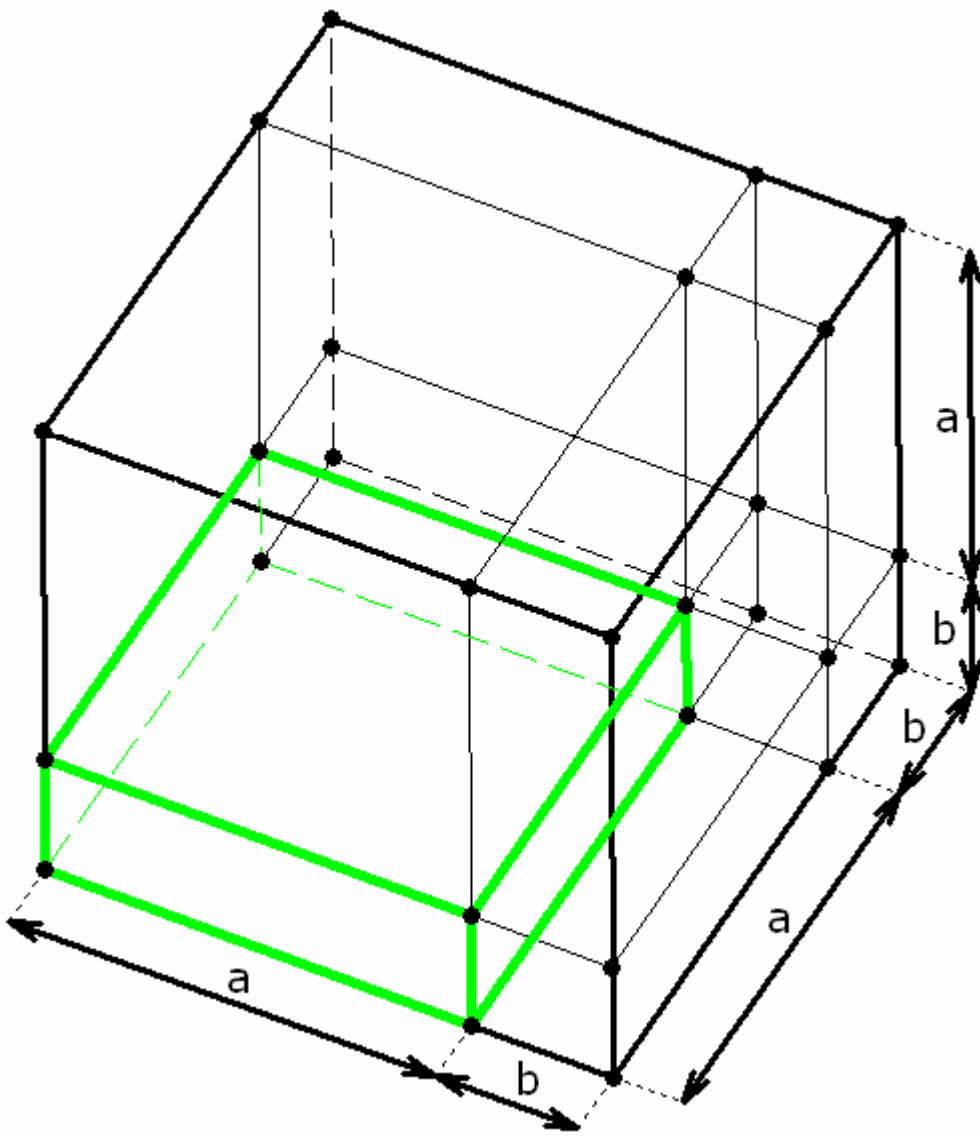

$$+ a^2 b$$

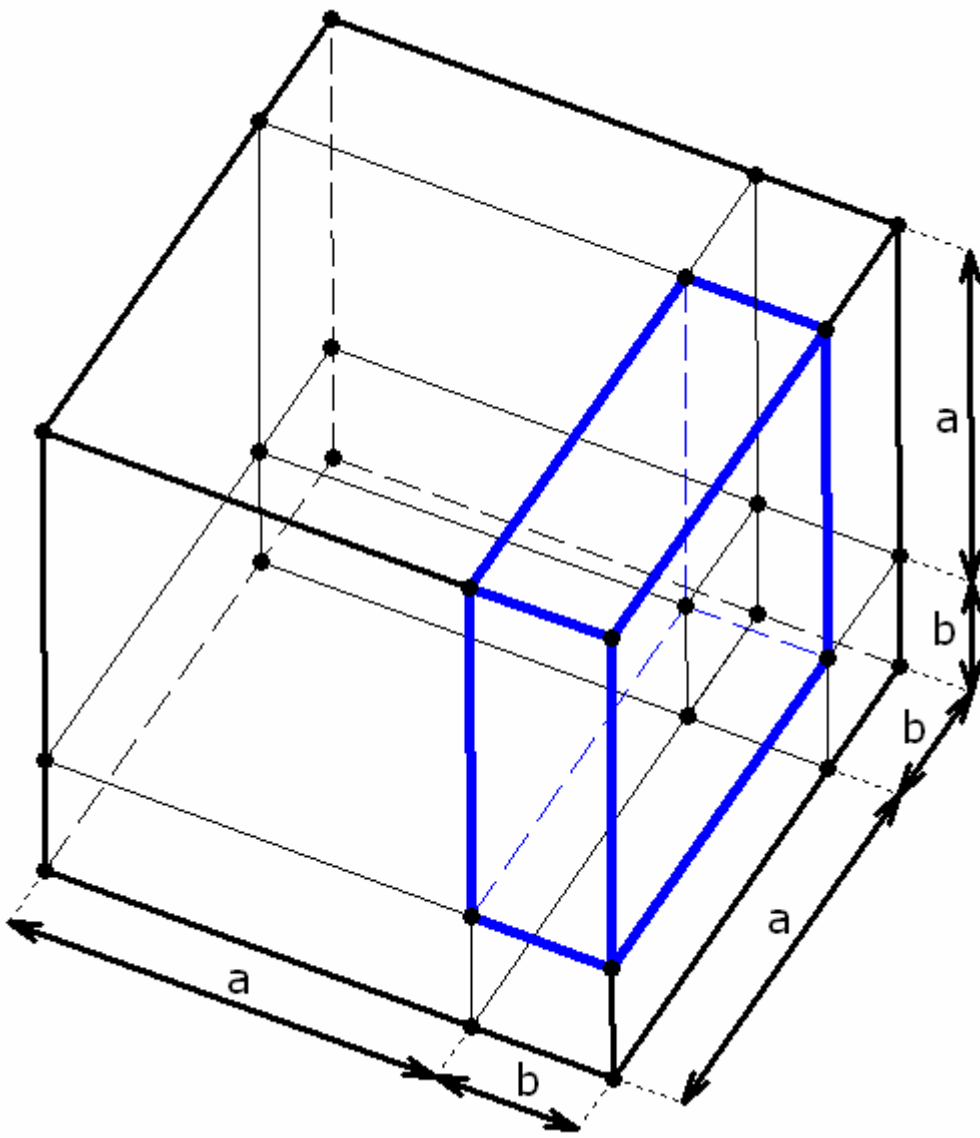

$$+ a^3$$

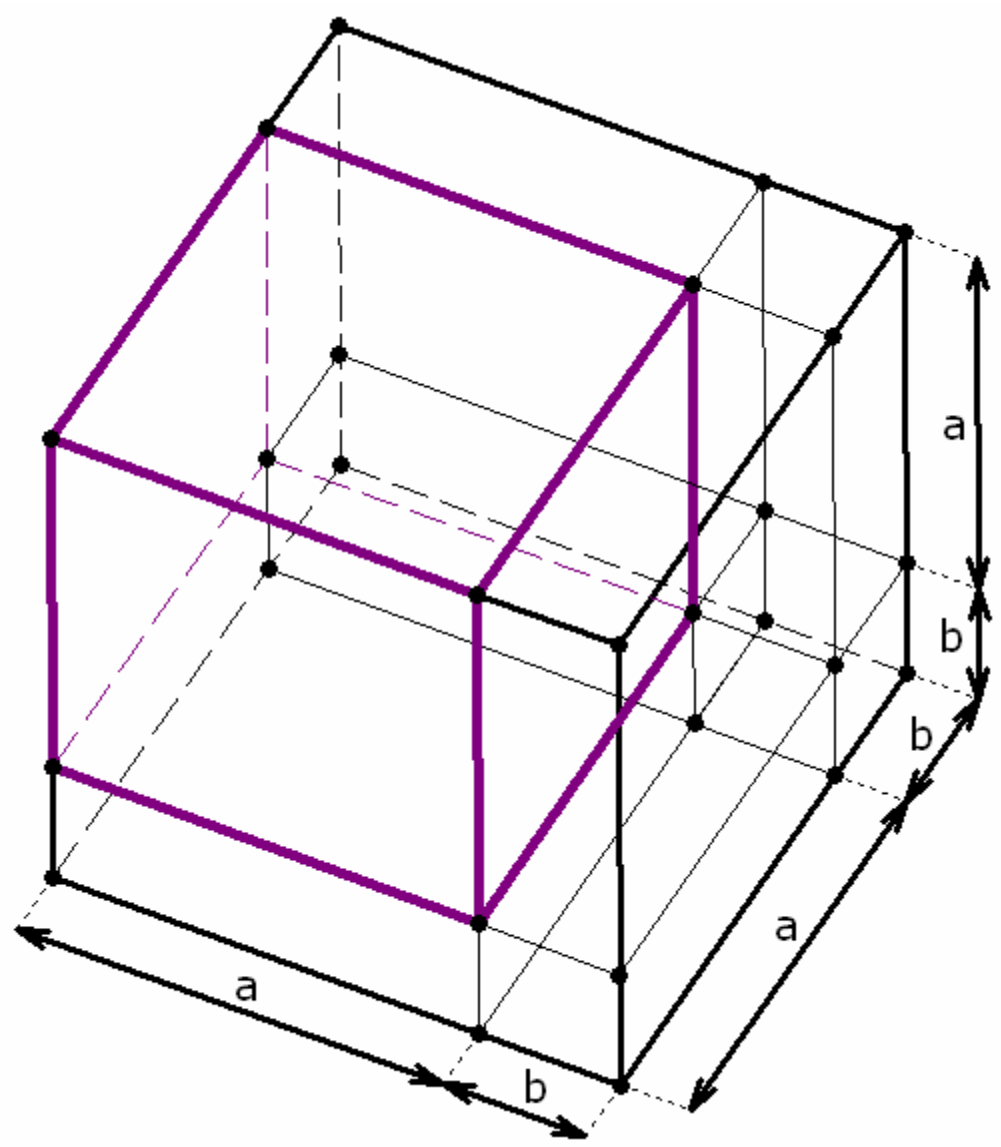

b^3

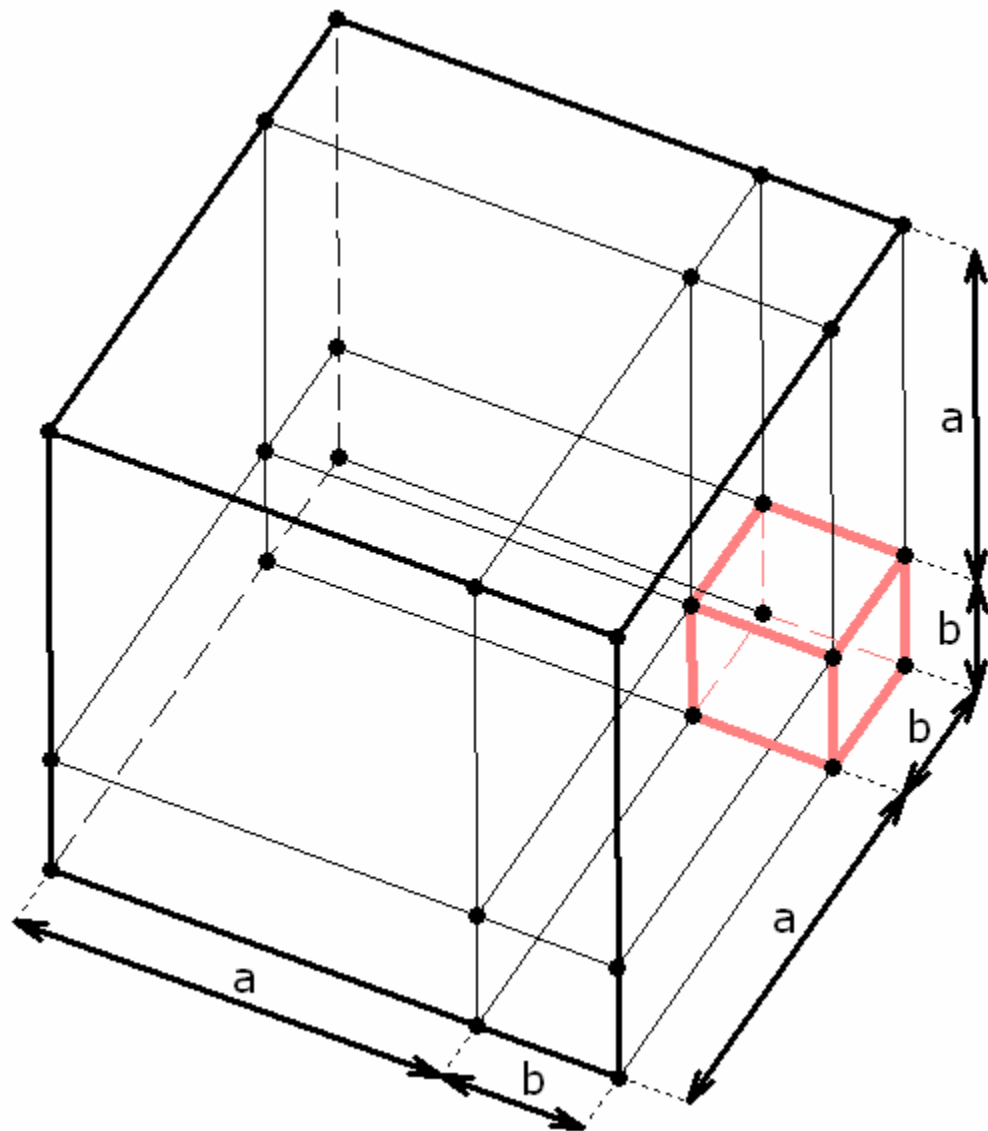

$$+ ab^2$$

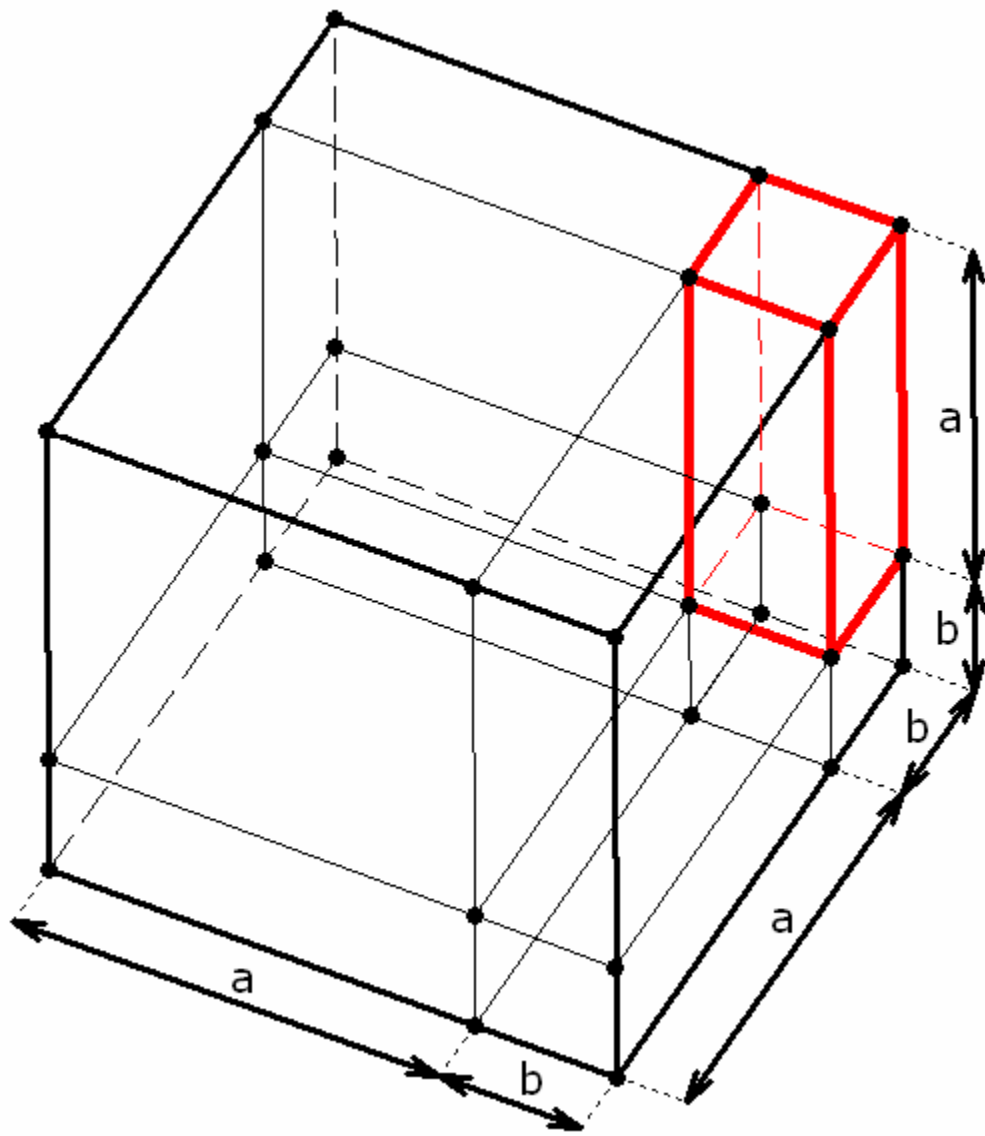

$$+ ab^2$$

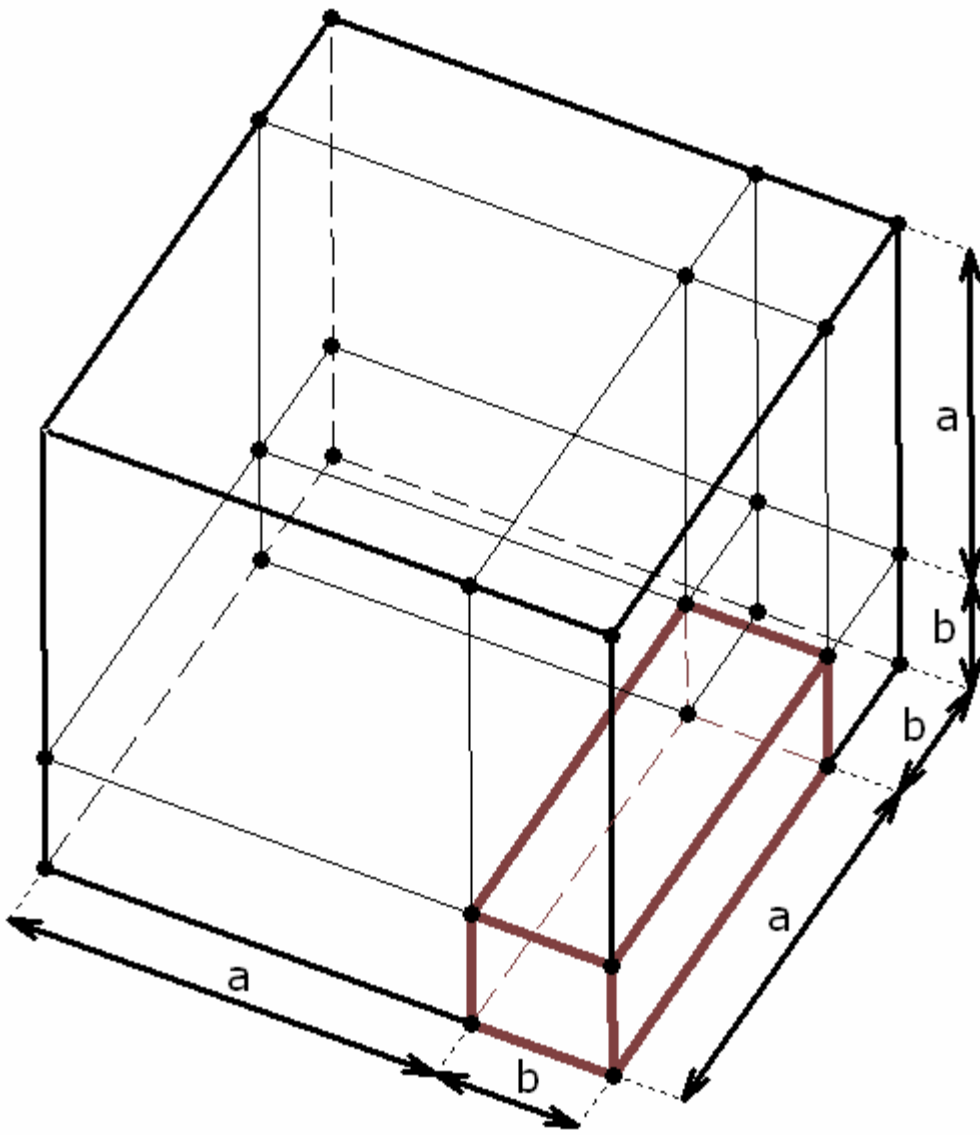

$$+ ab^2$$

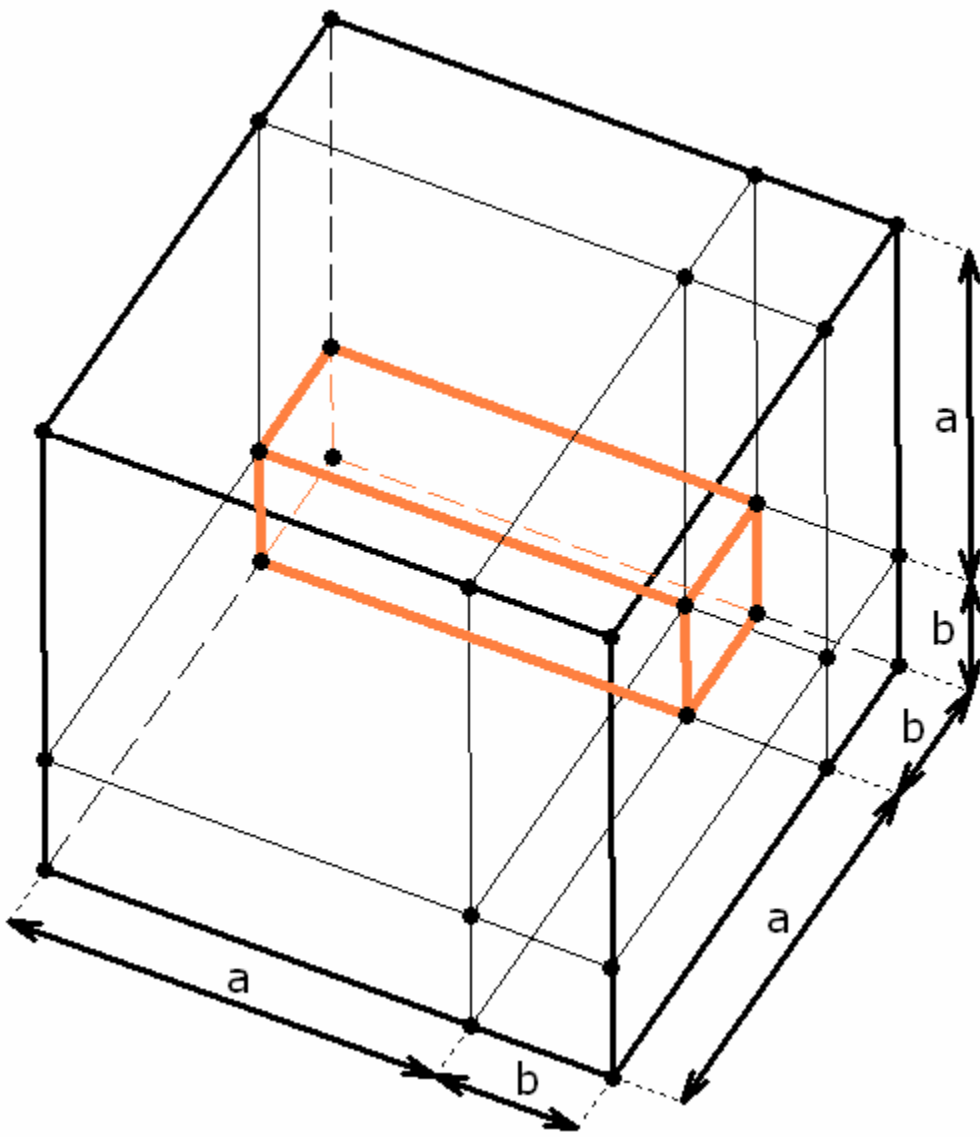

$$+ a^2 b$$

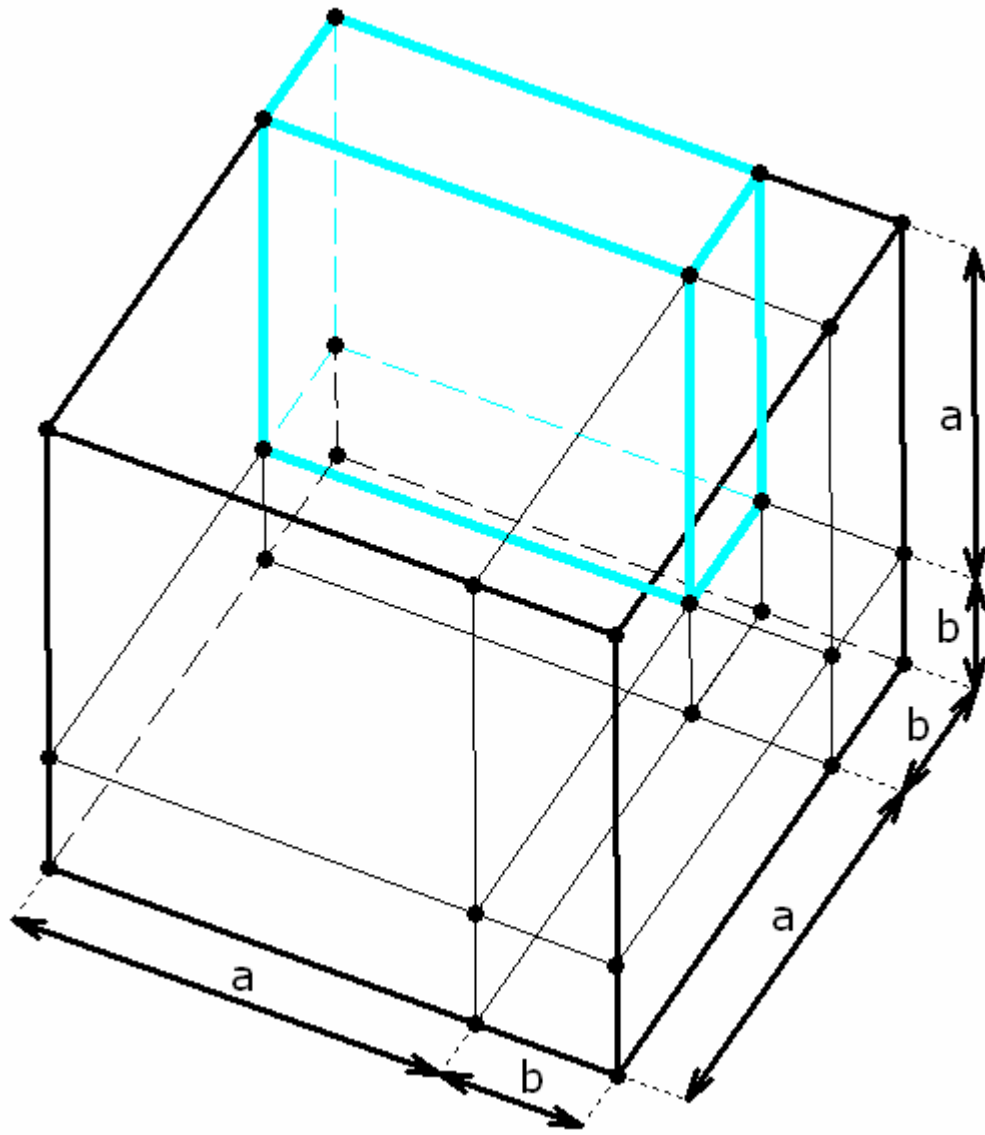

$$+ a^2 b$$

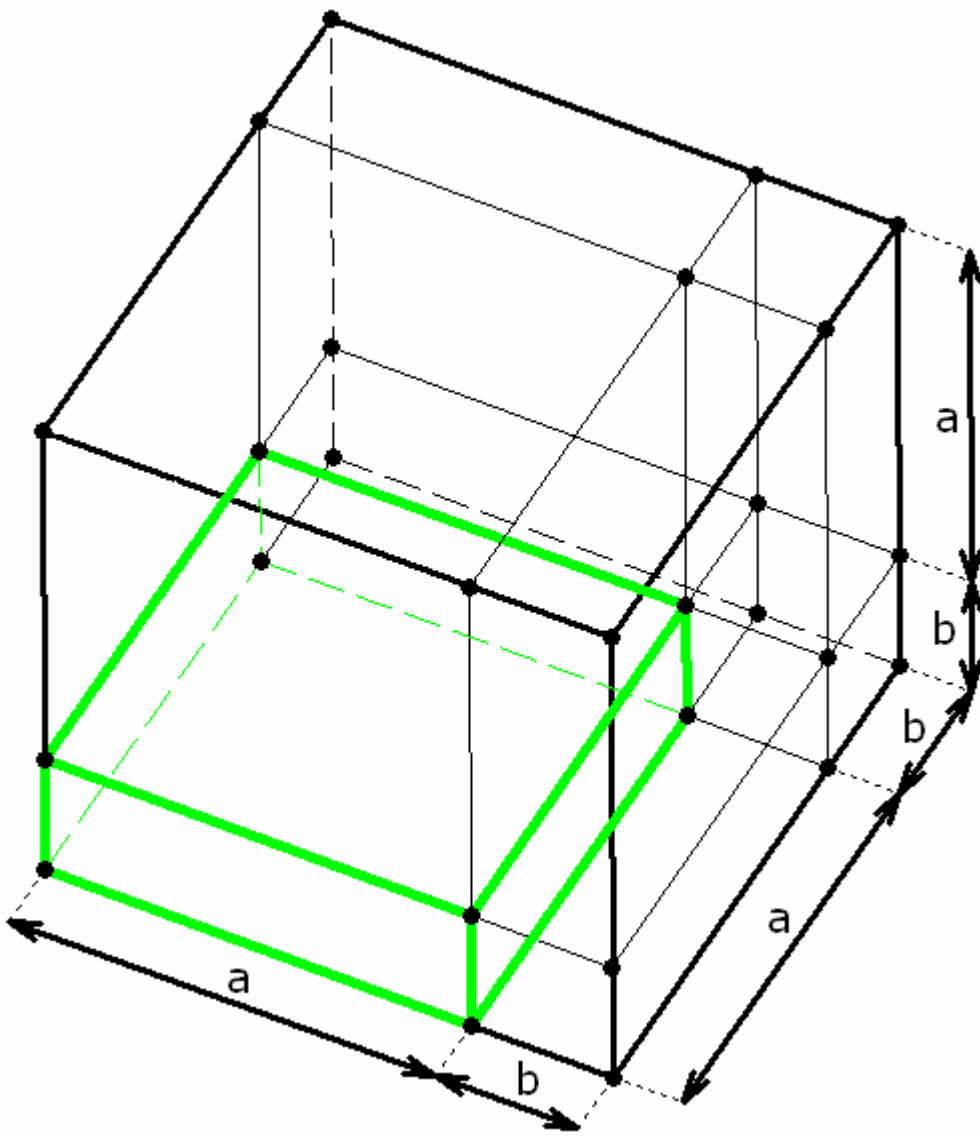

$$+ a^2 b$$

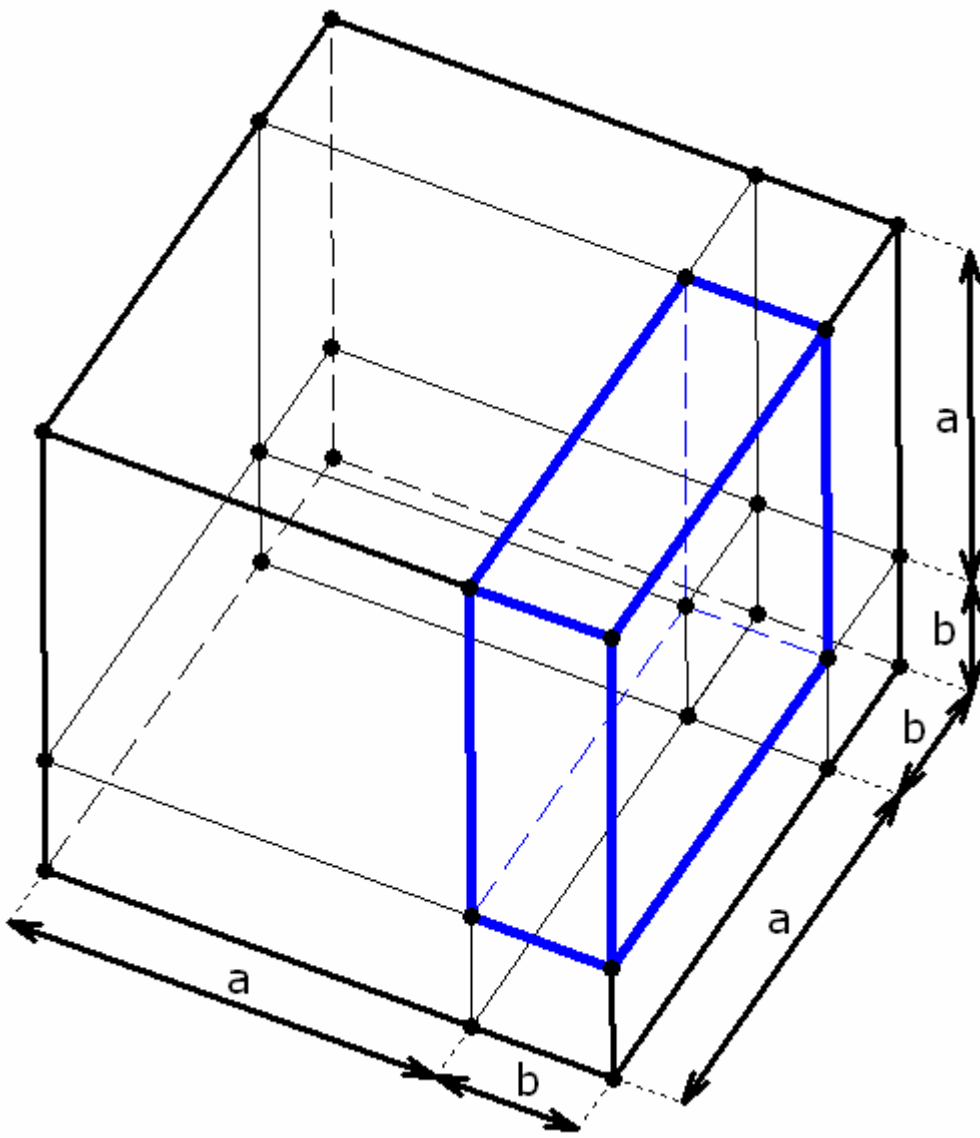

$$+ a^3$$

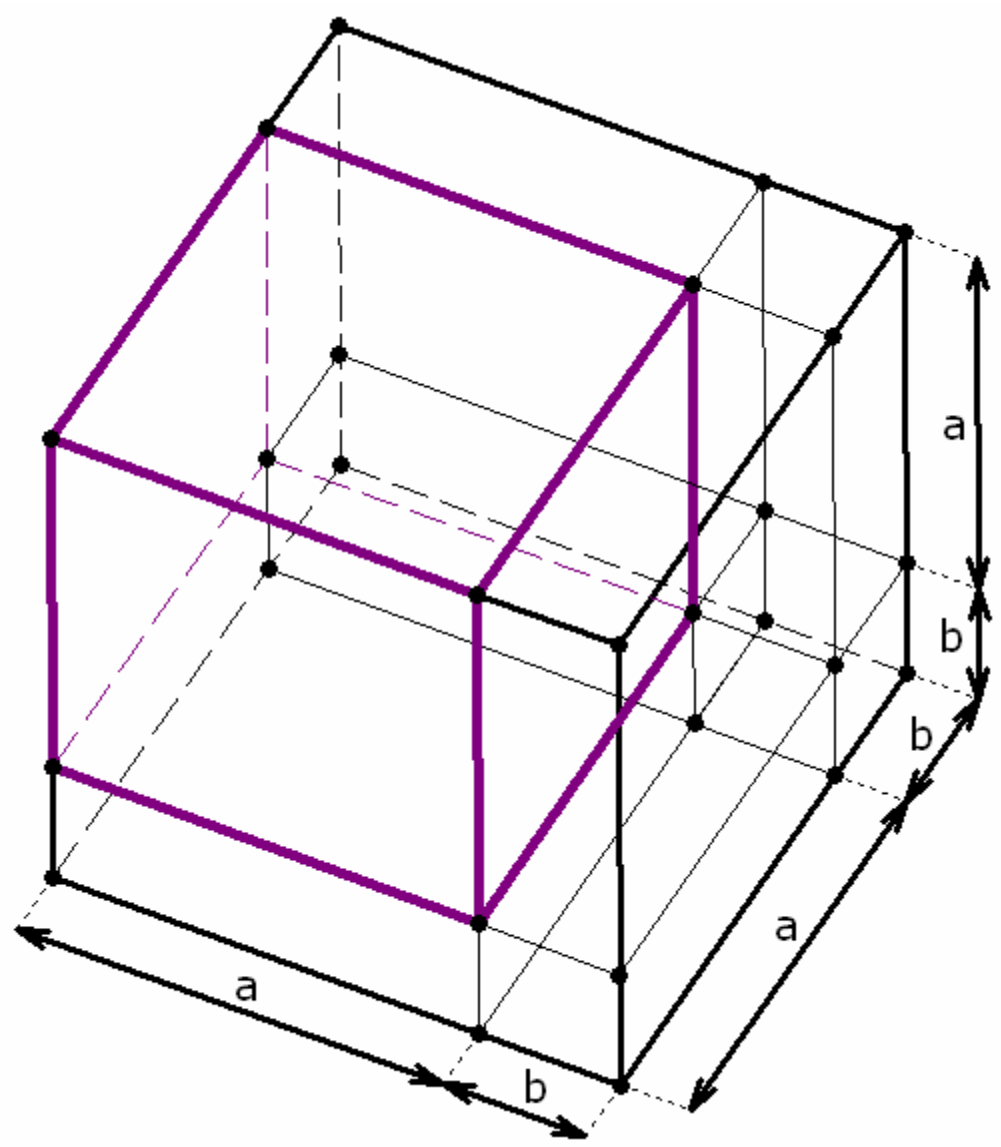

b^3

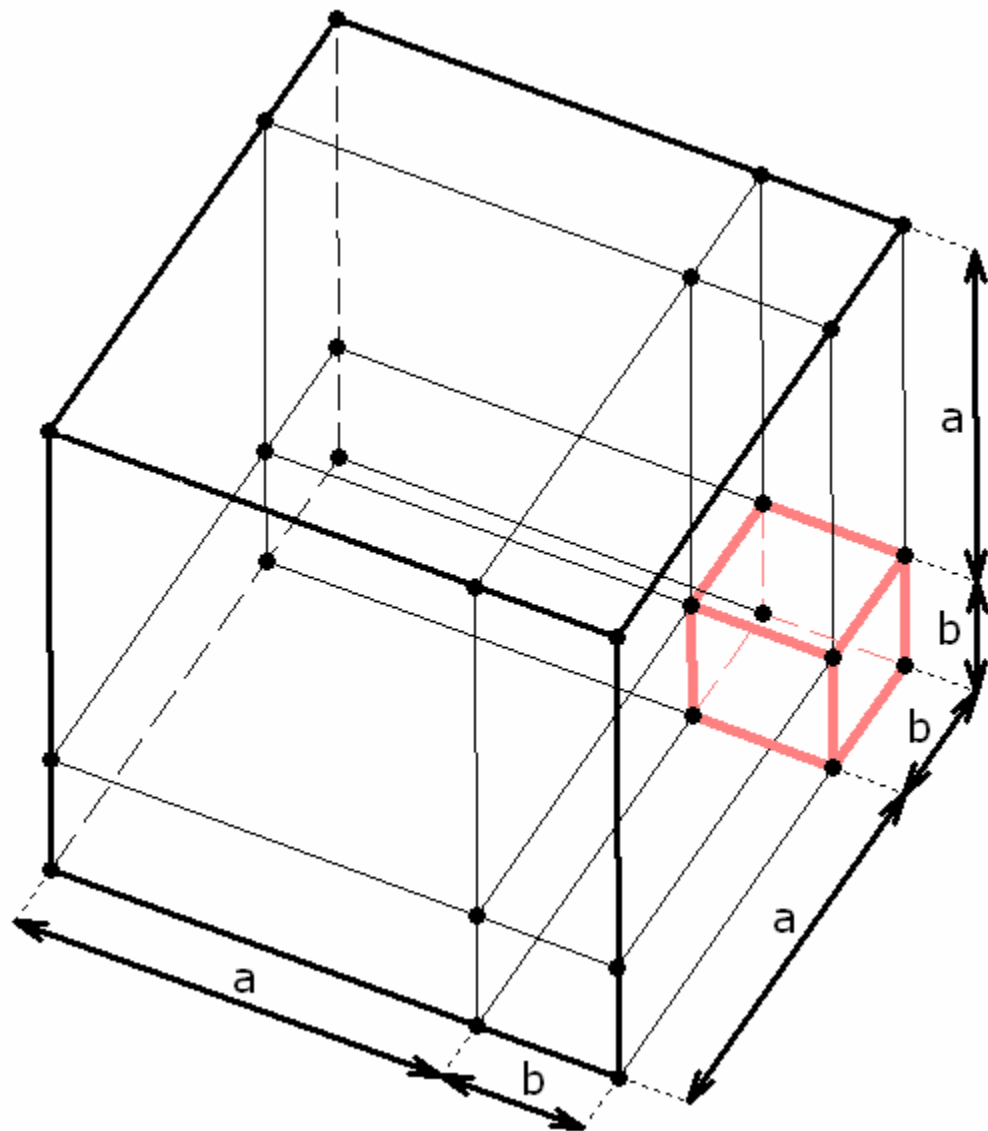

$$+ ab^2$$

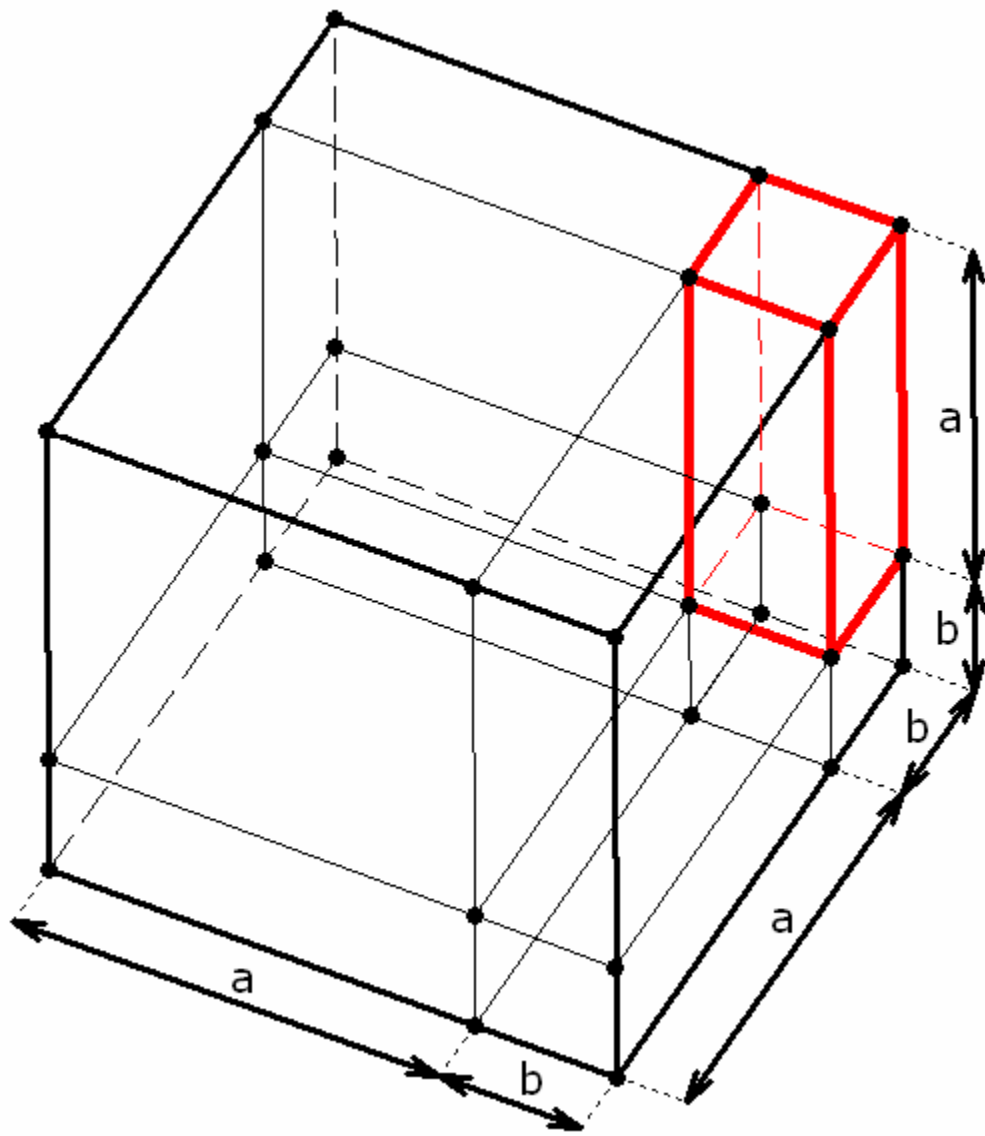

$$+ ab^2$$

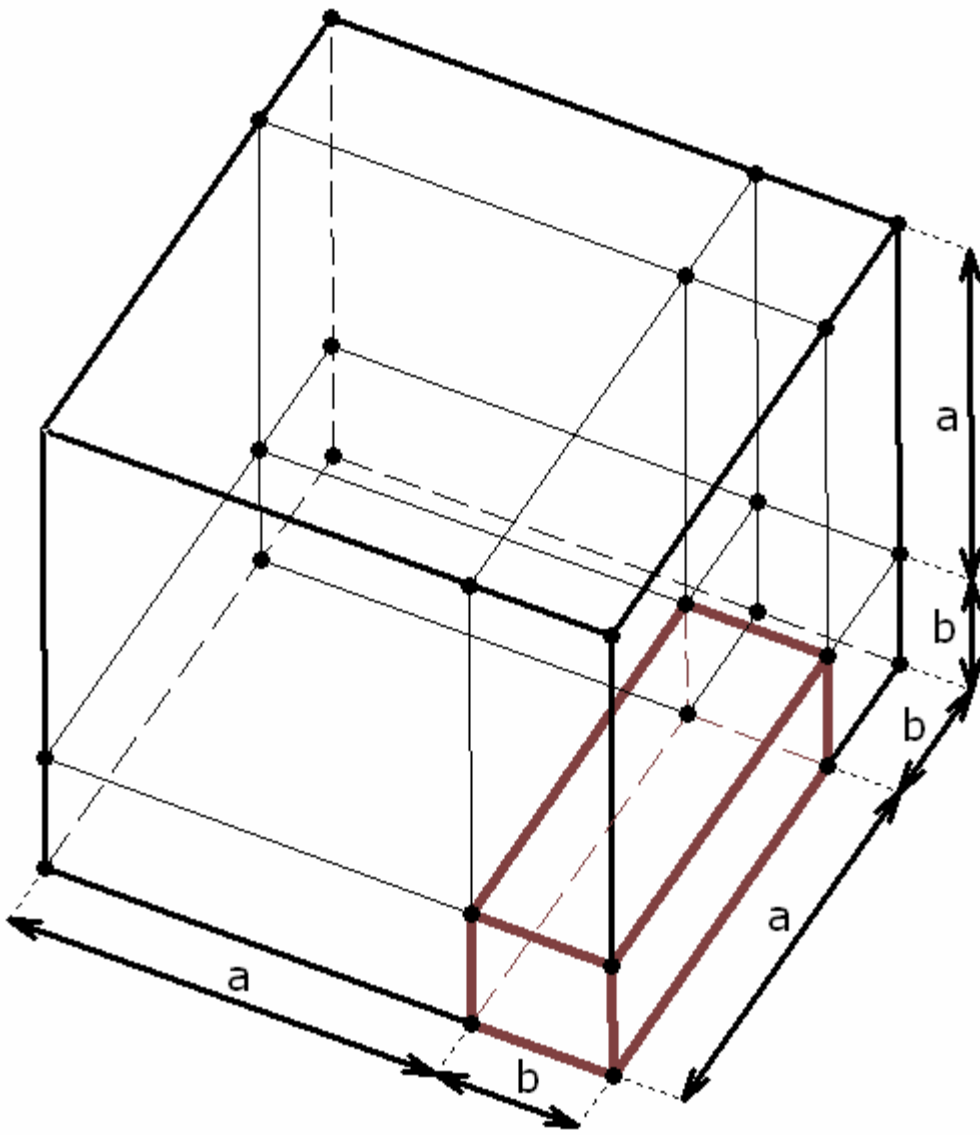

$$+ ab^2$$

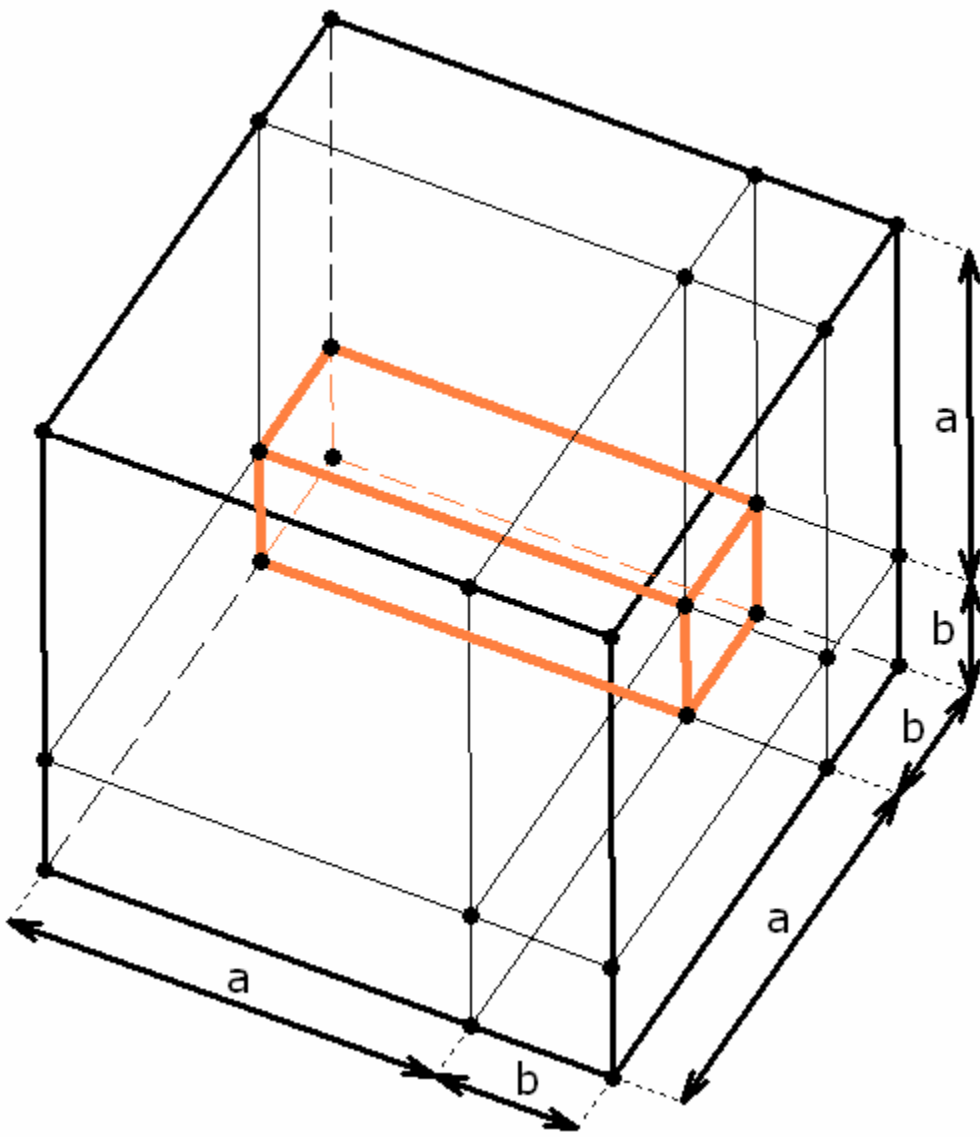

$$+ a^2 b$$

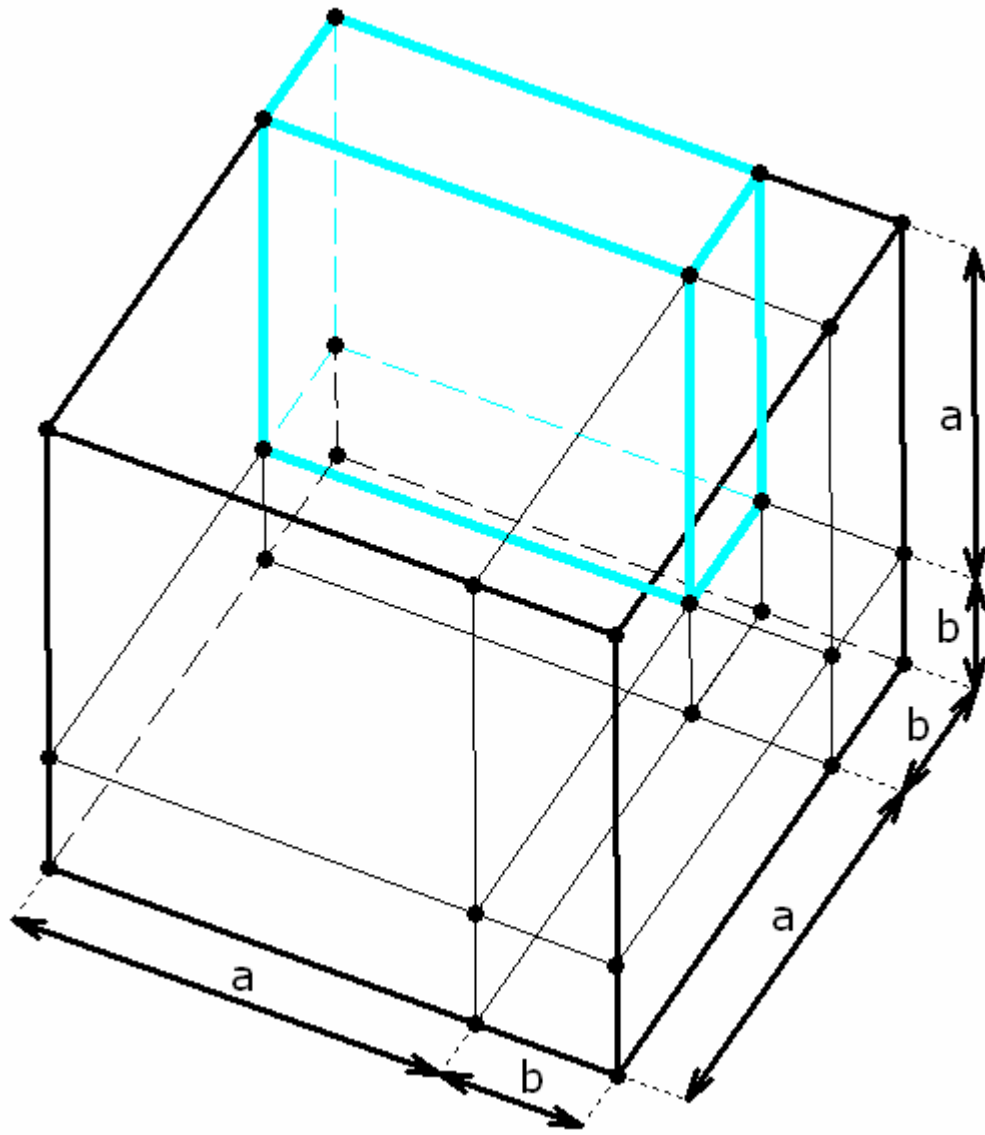

$$+ a^2 b$$

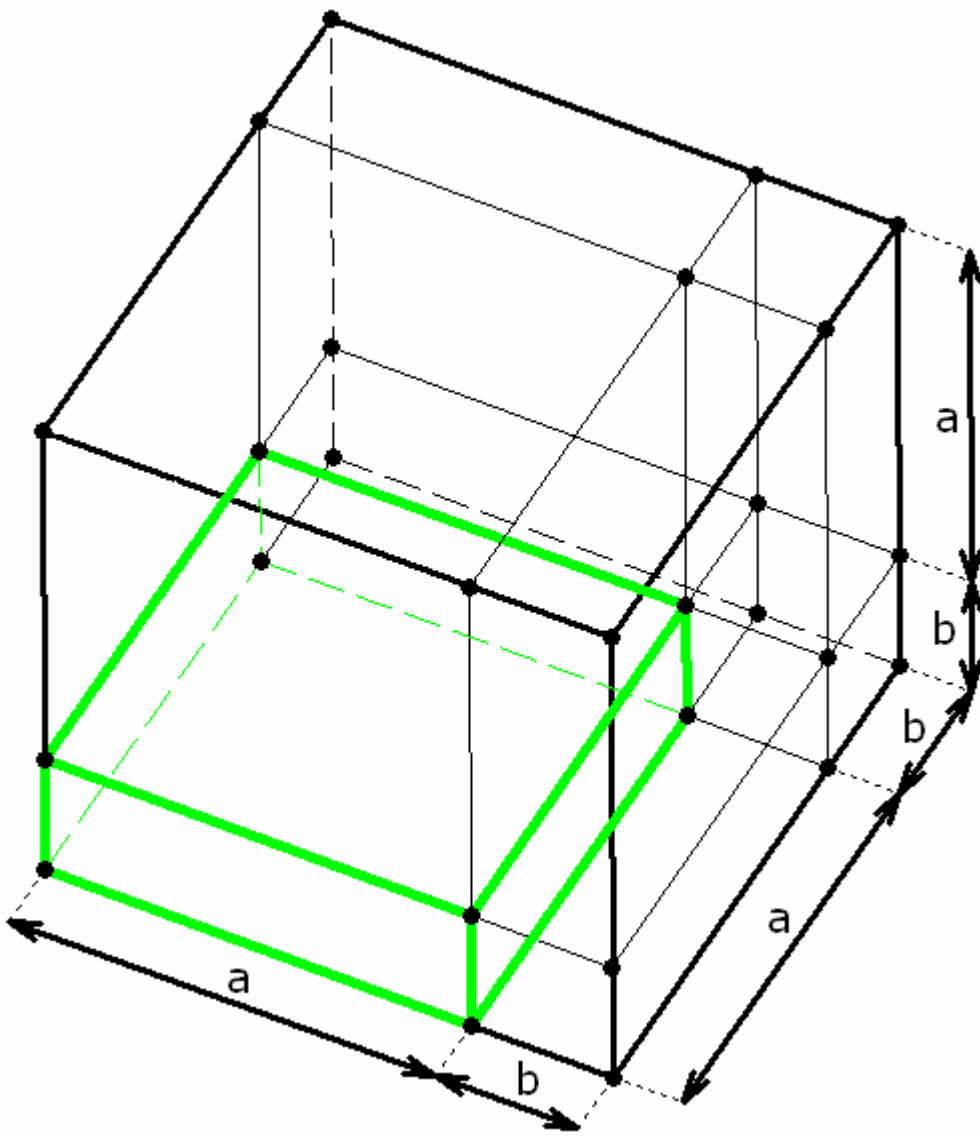

$$+ a^2 b$$

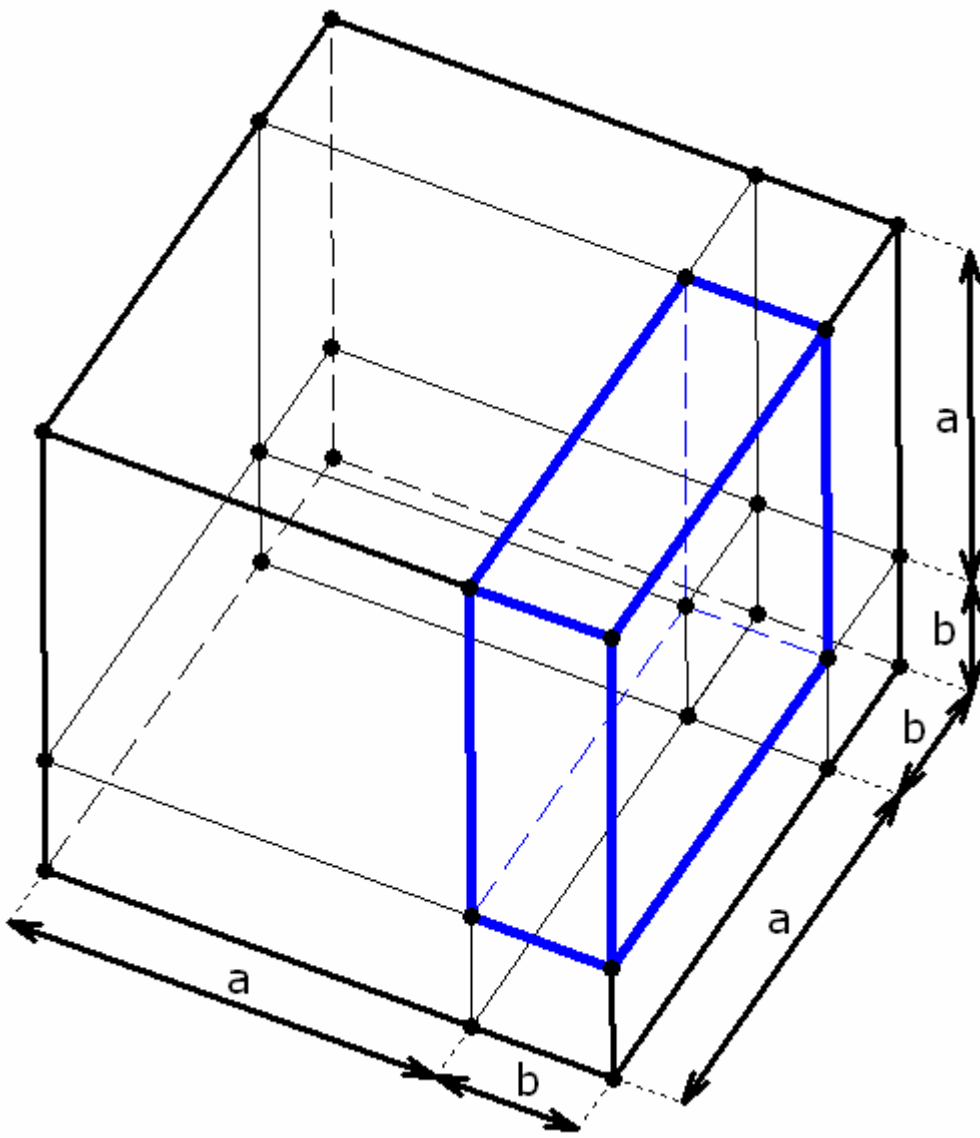

$$+ a^3$$

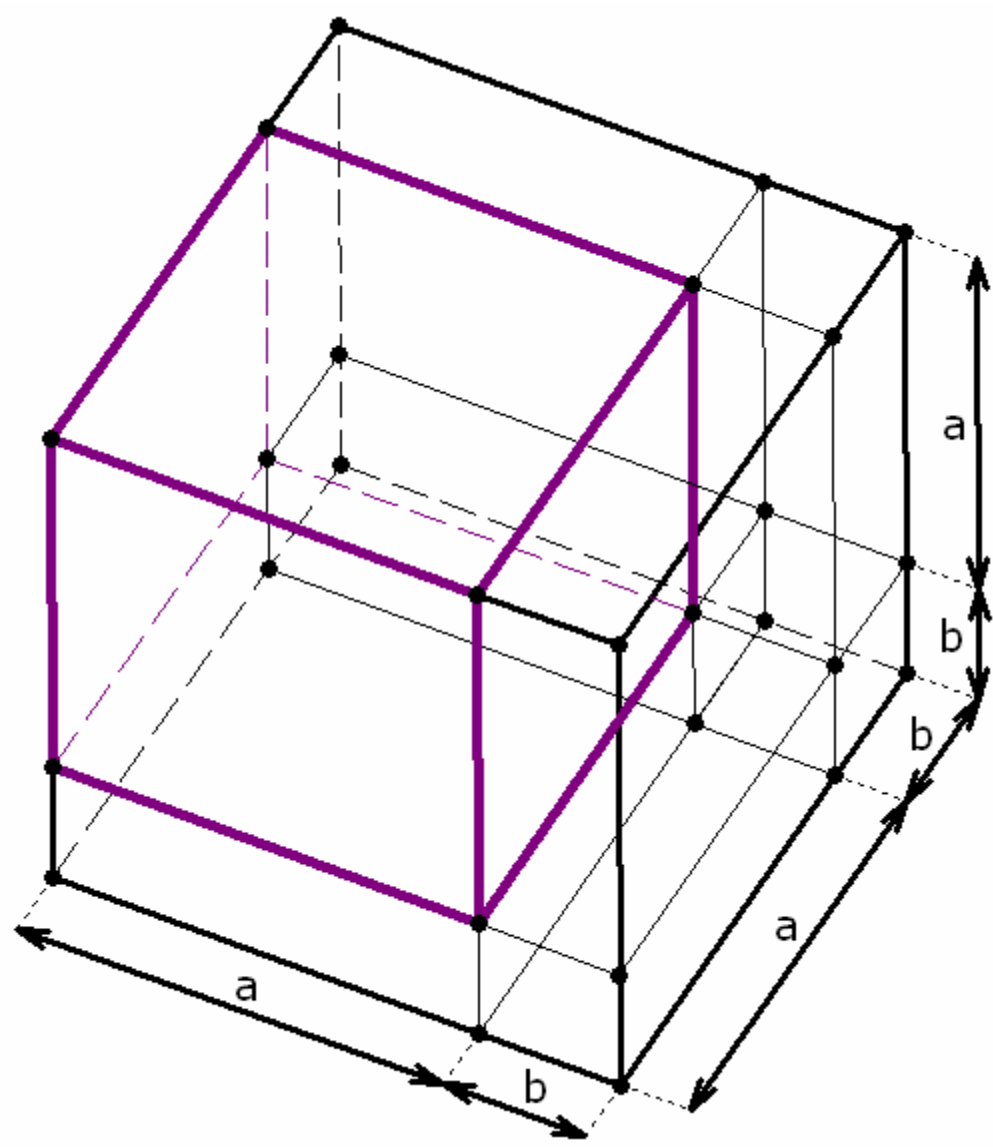

b^3

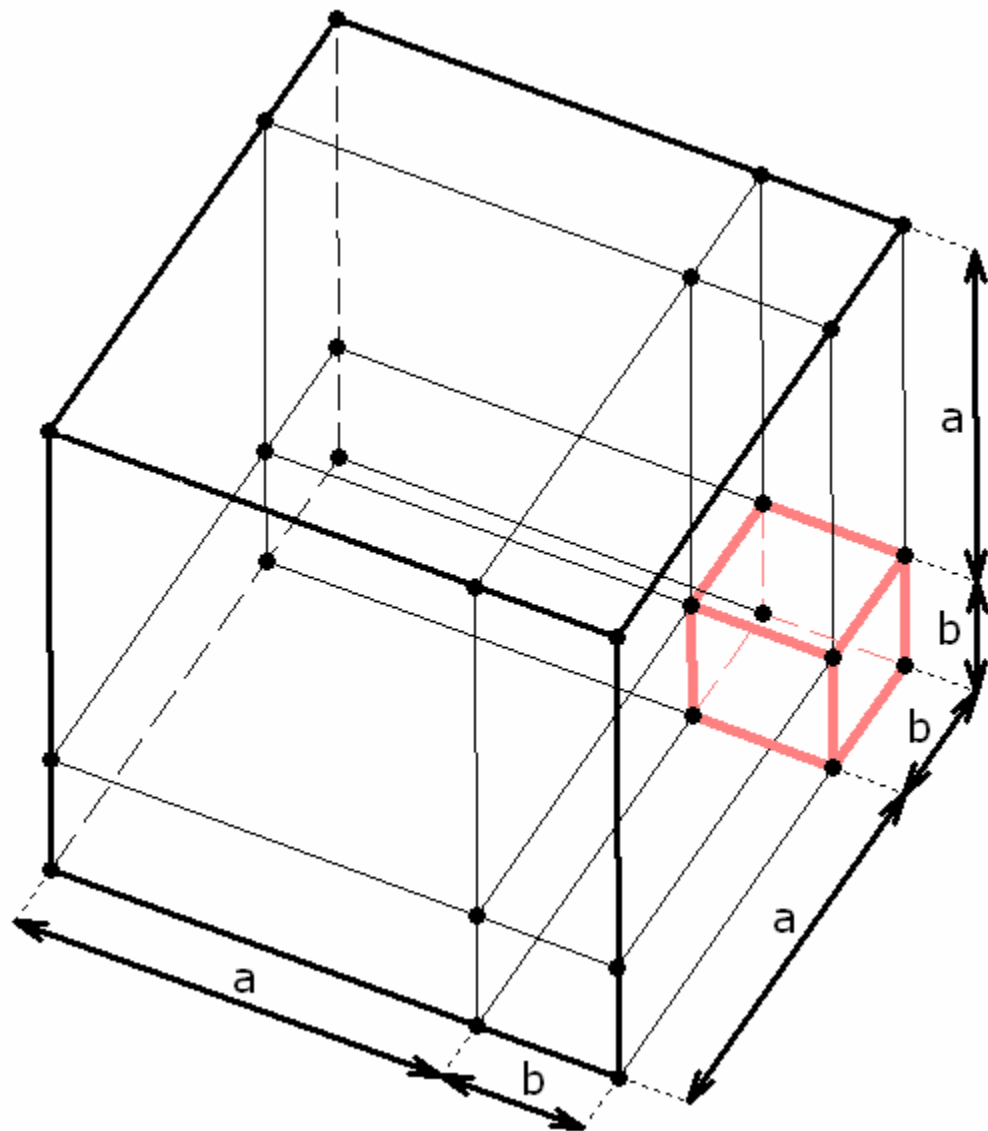

$$+ ab^2$$

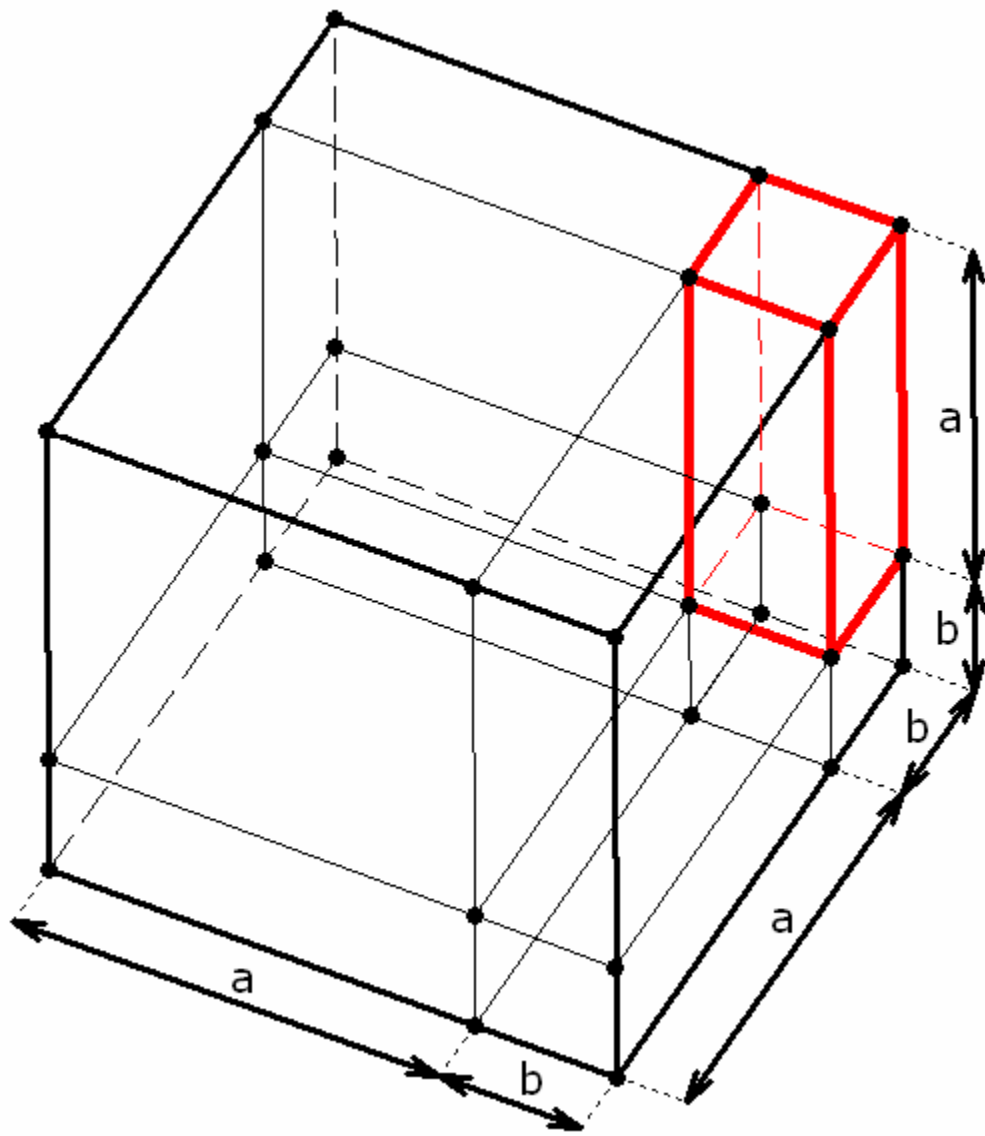

$$+ ab^2$$

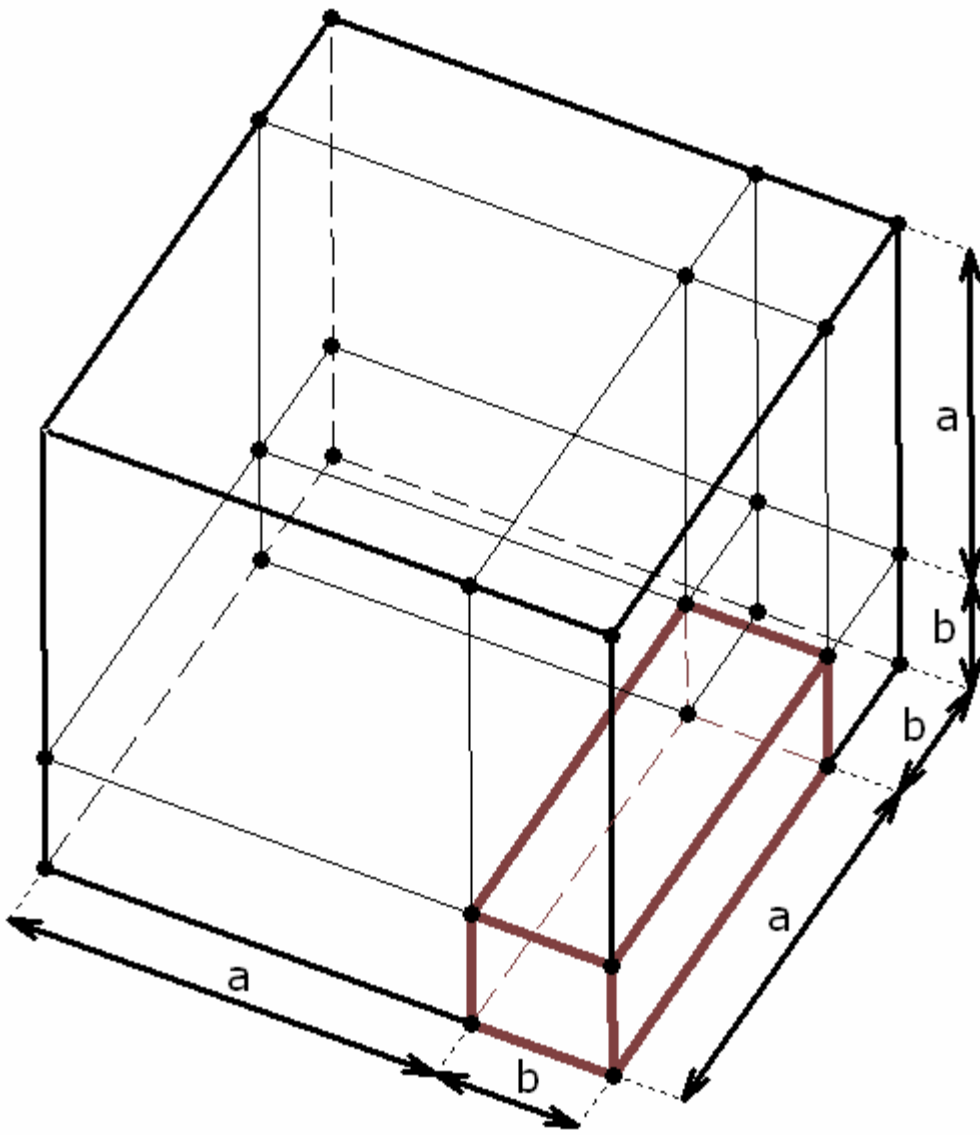

$$+ ab^2$$

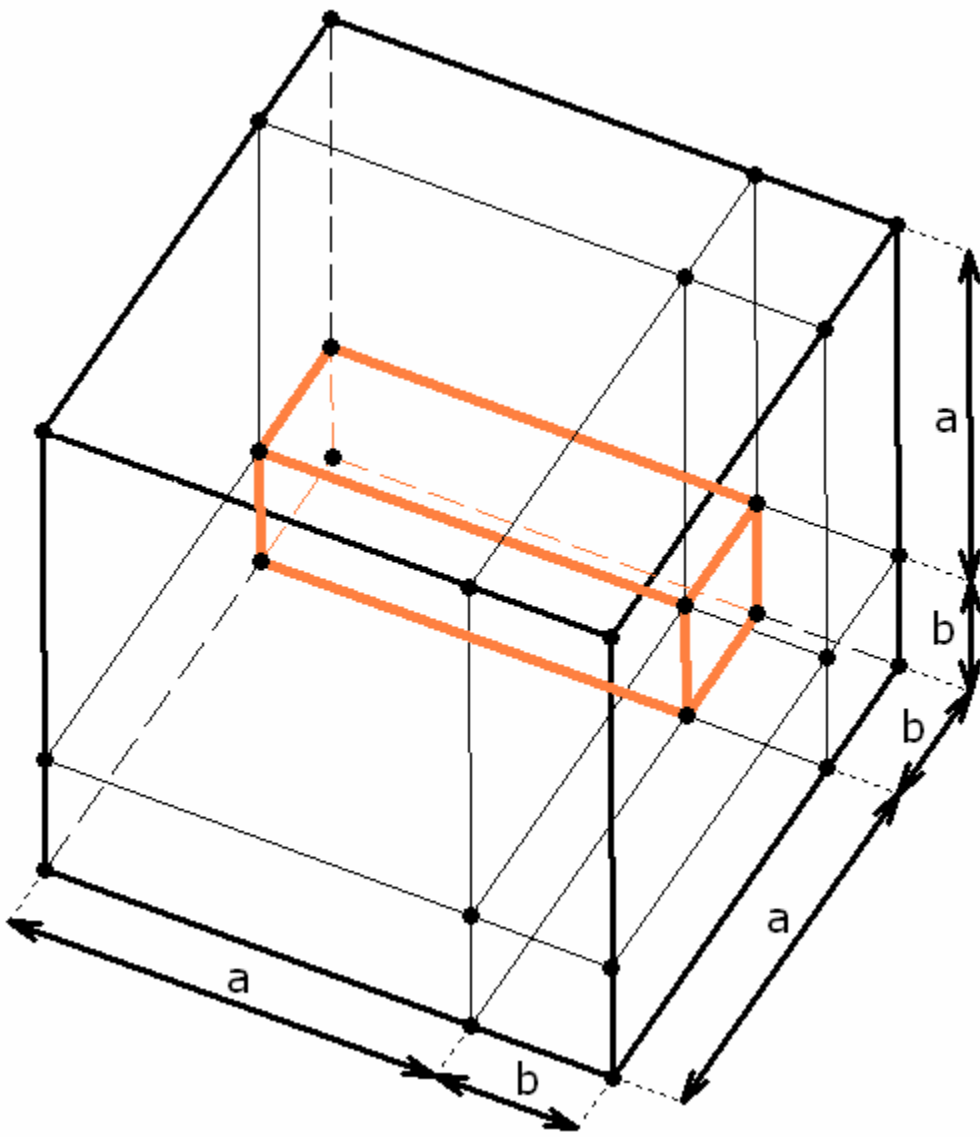

$$+ a^2 b$$

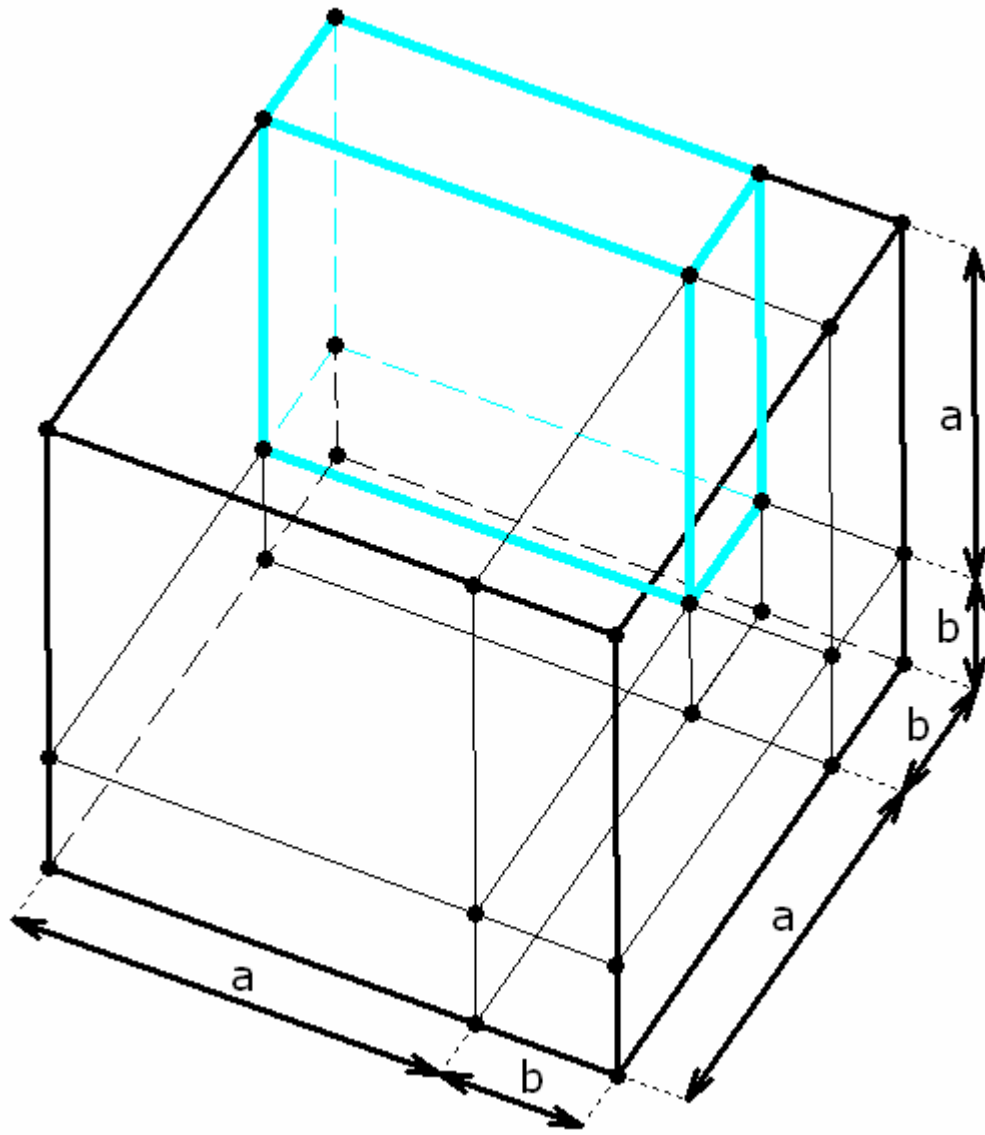

$$+ a^2 b$$

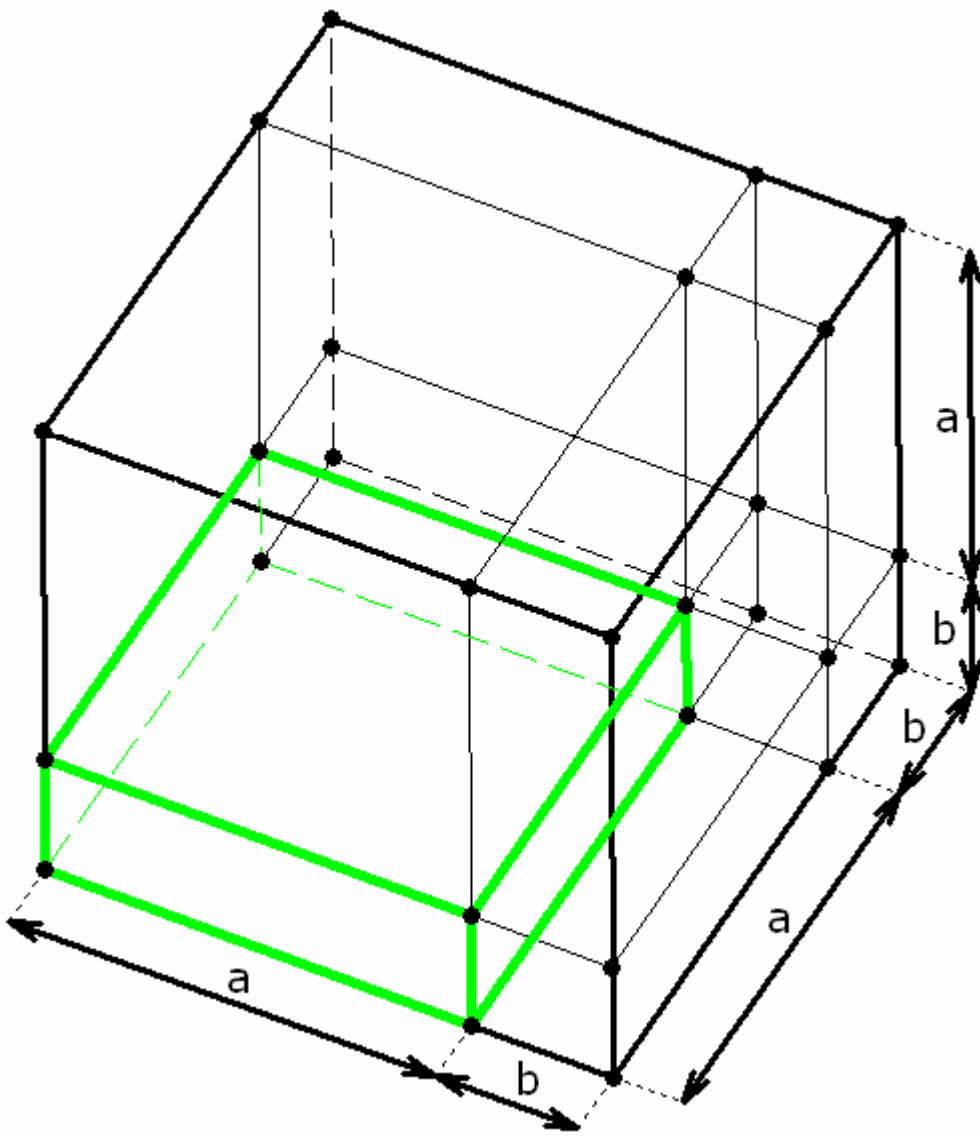

$$+ a^2 b$$

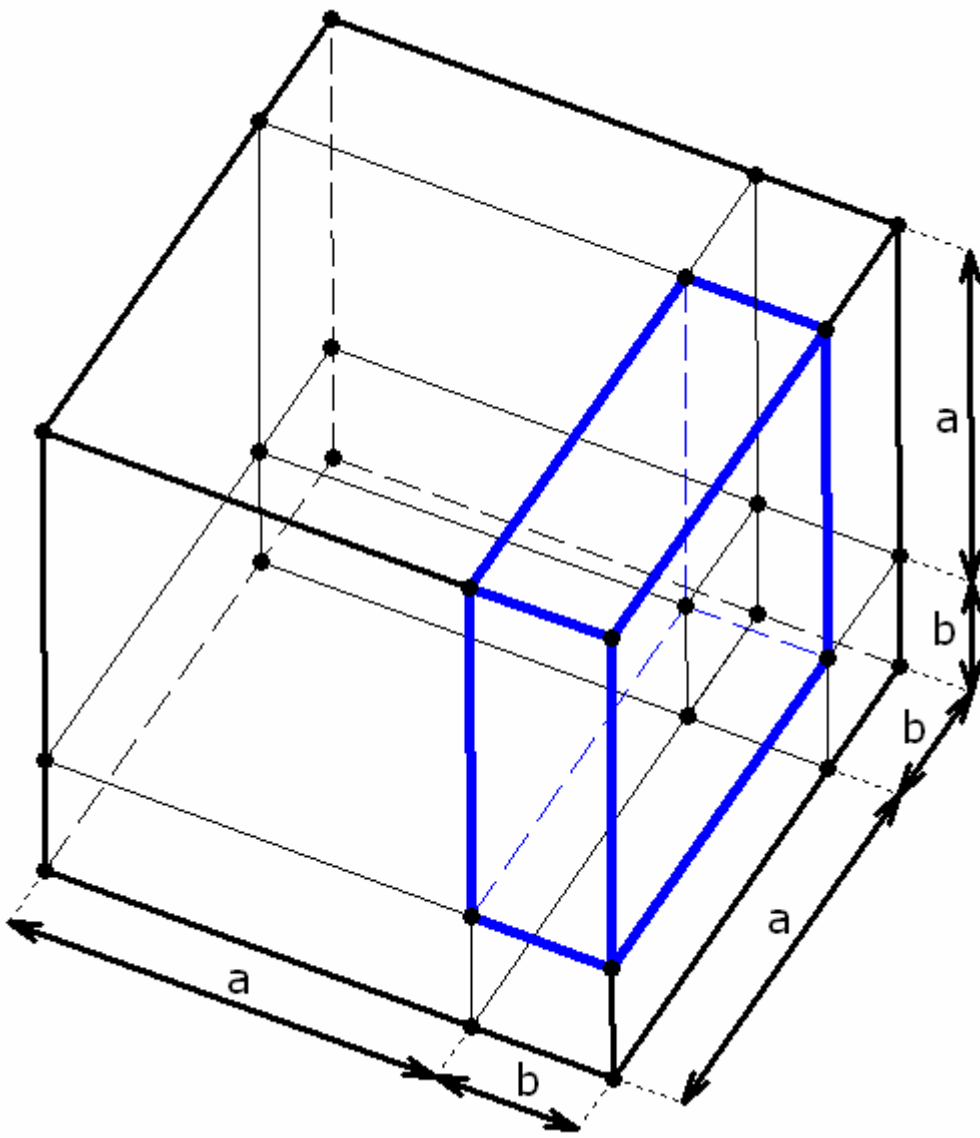

$$+ a^3$$

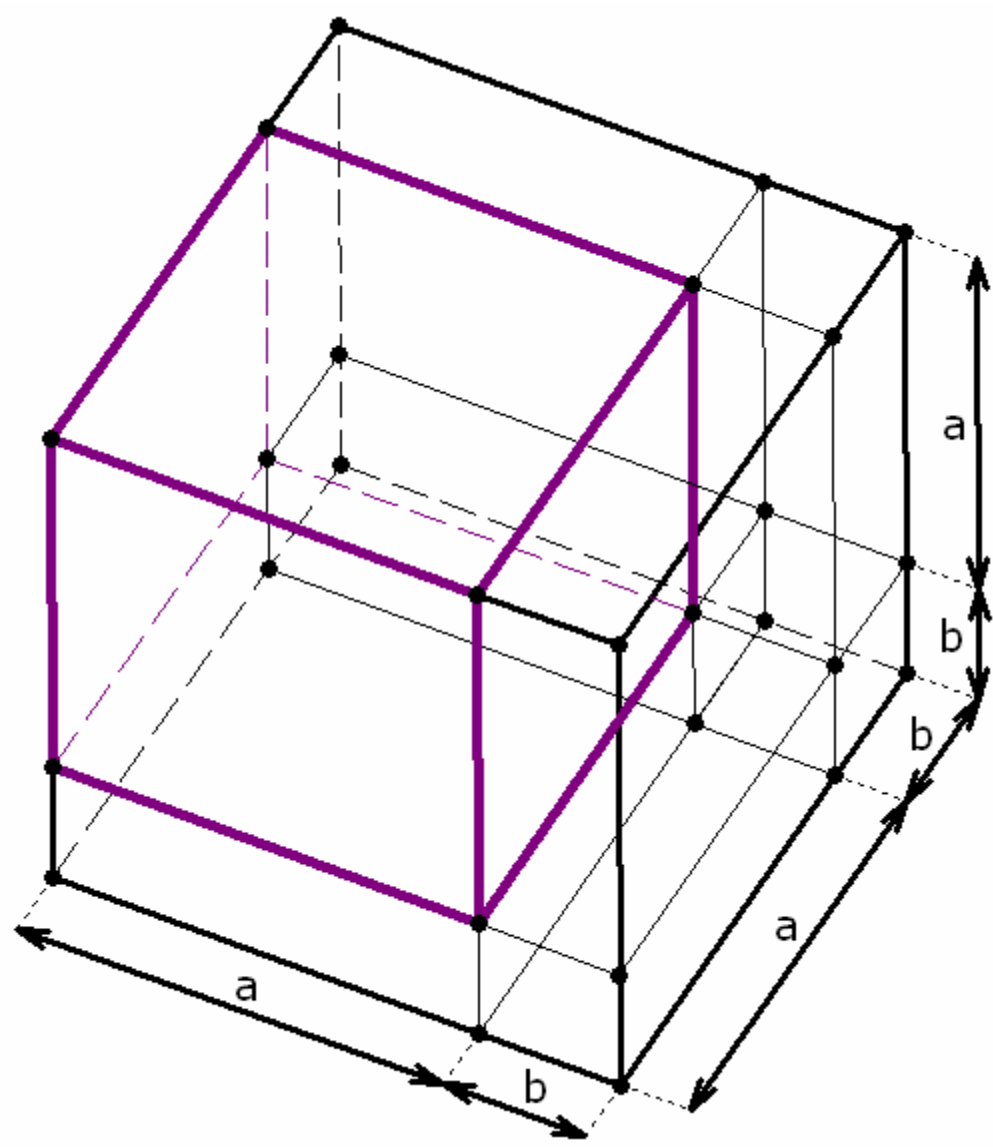

b^3

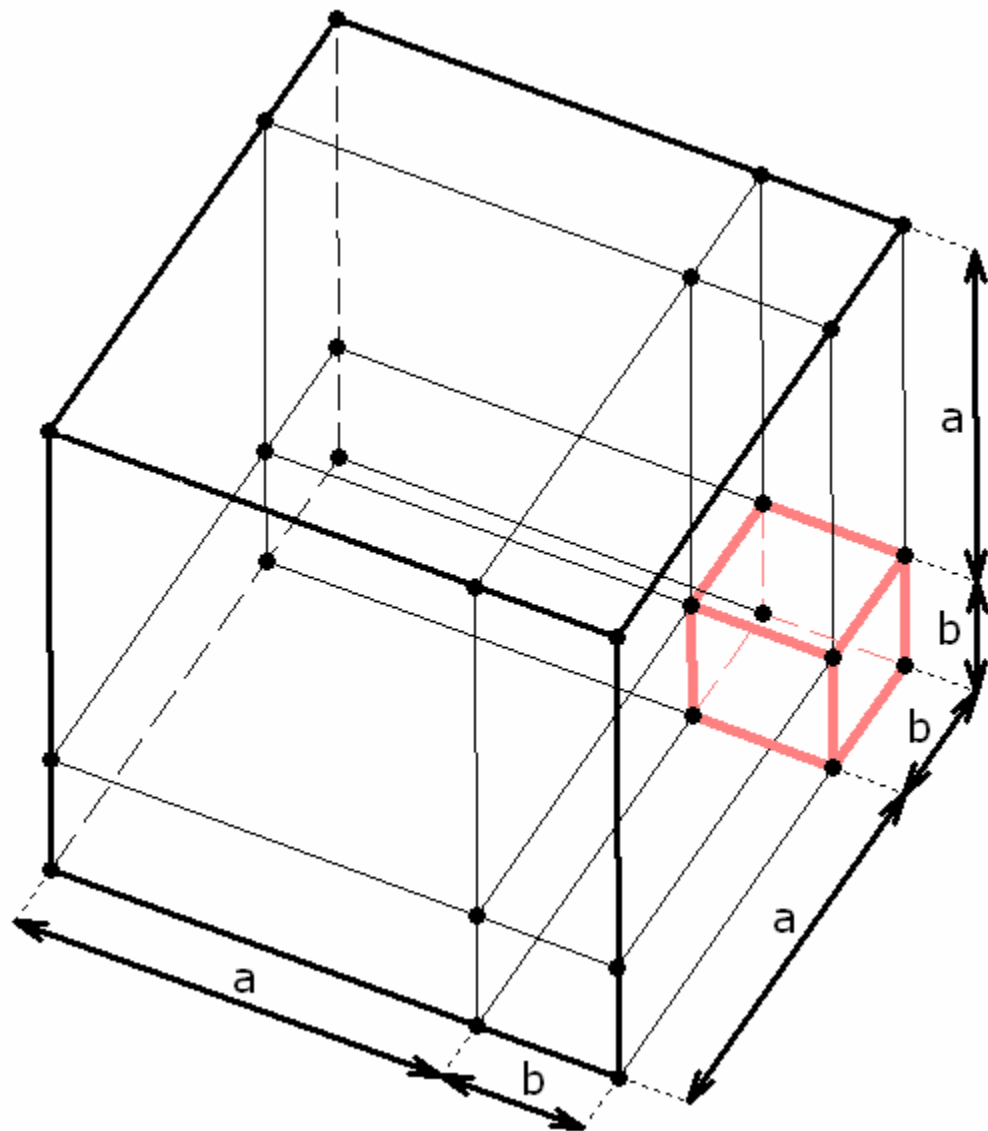

$$+ ab^2$$

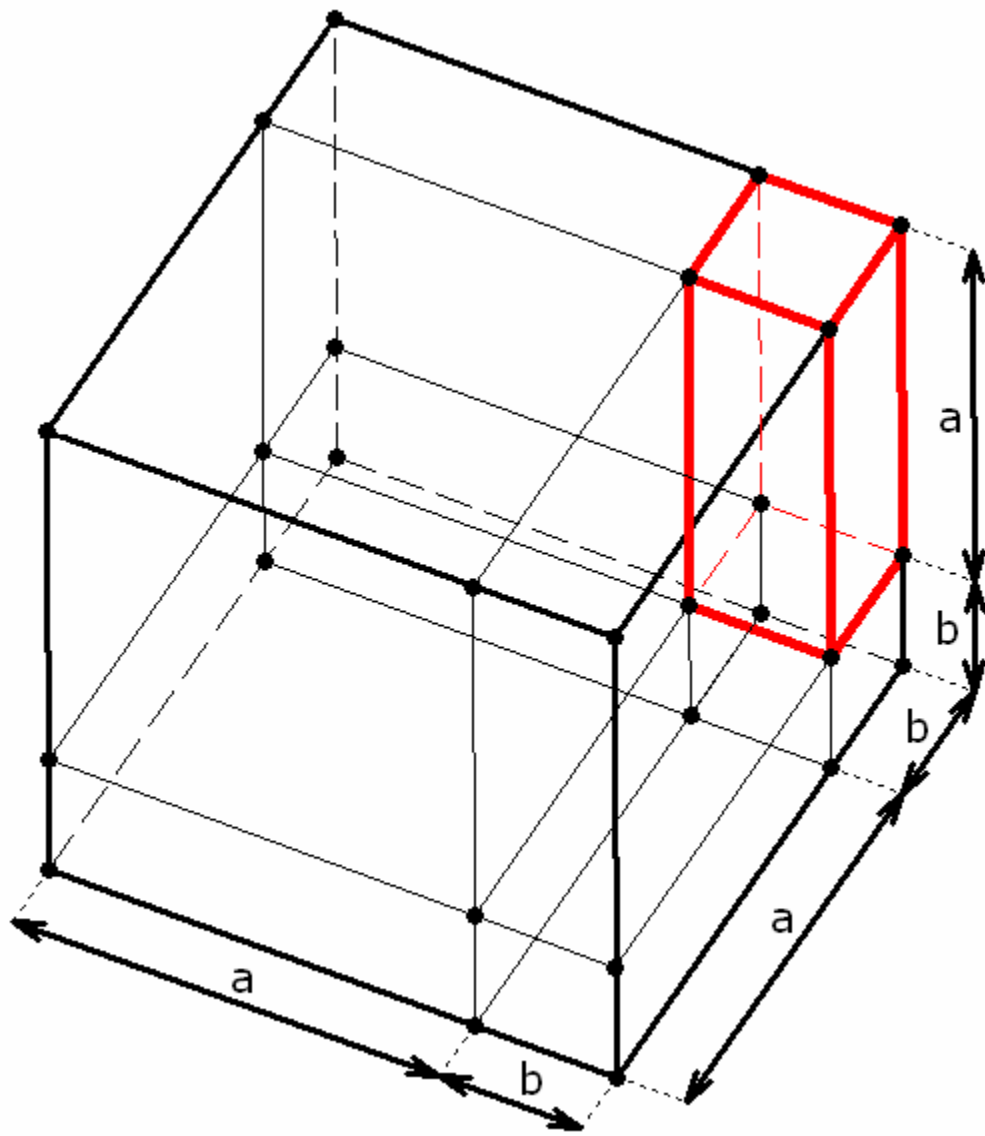

$$+ ab^2$$

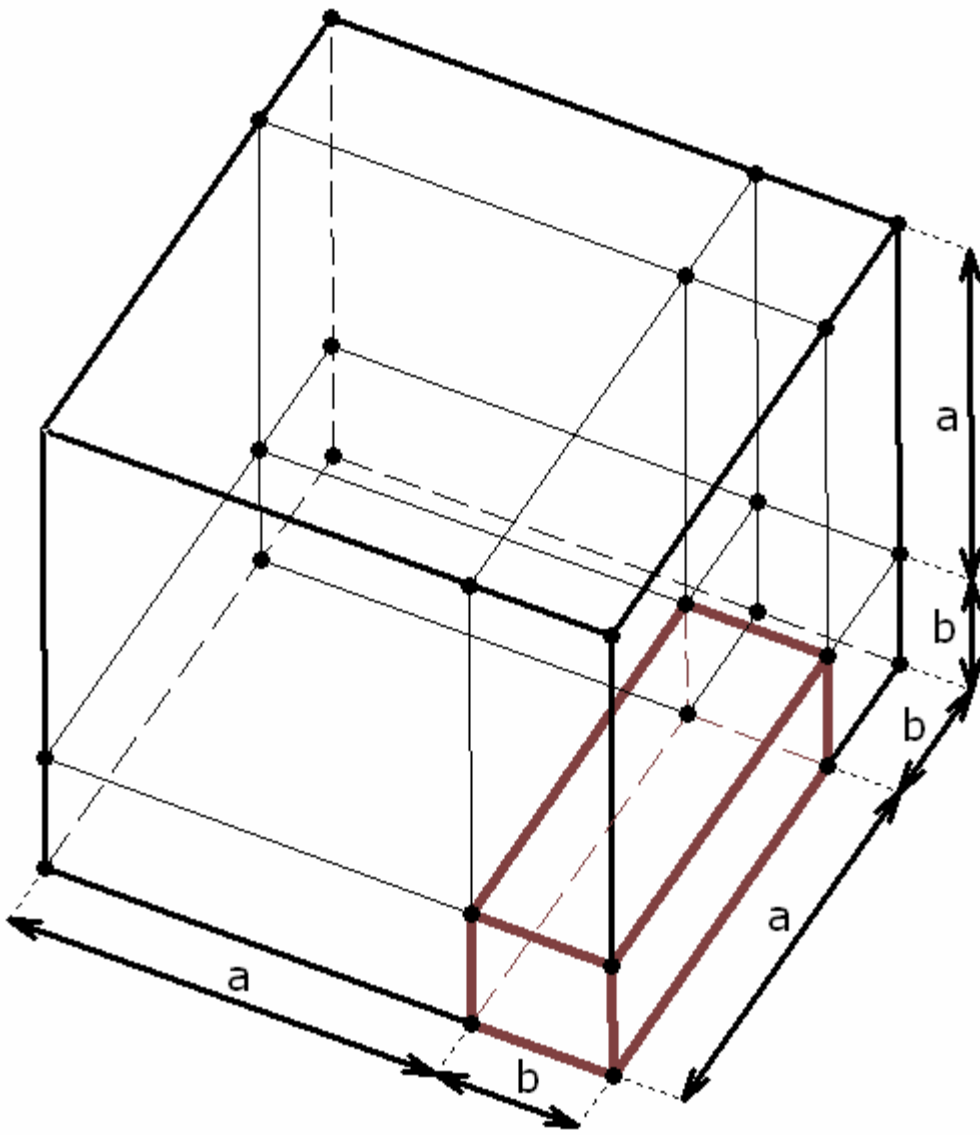

$$+ ab^2$$

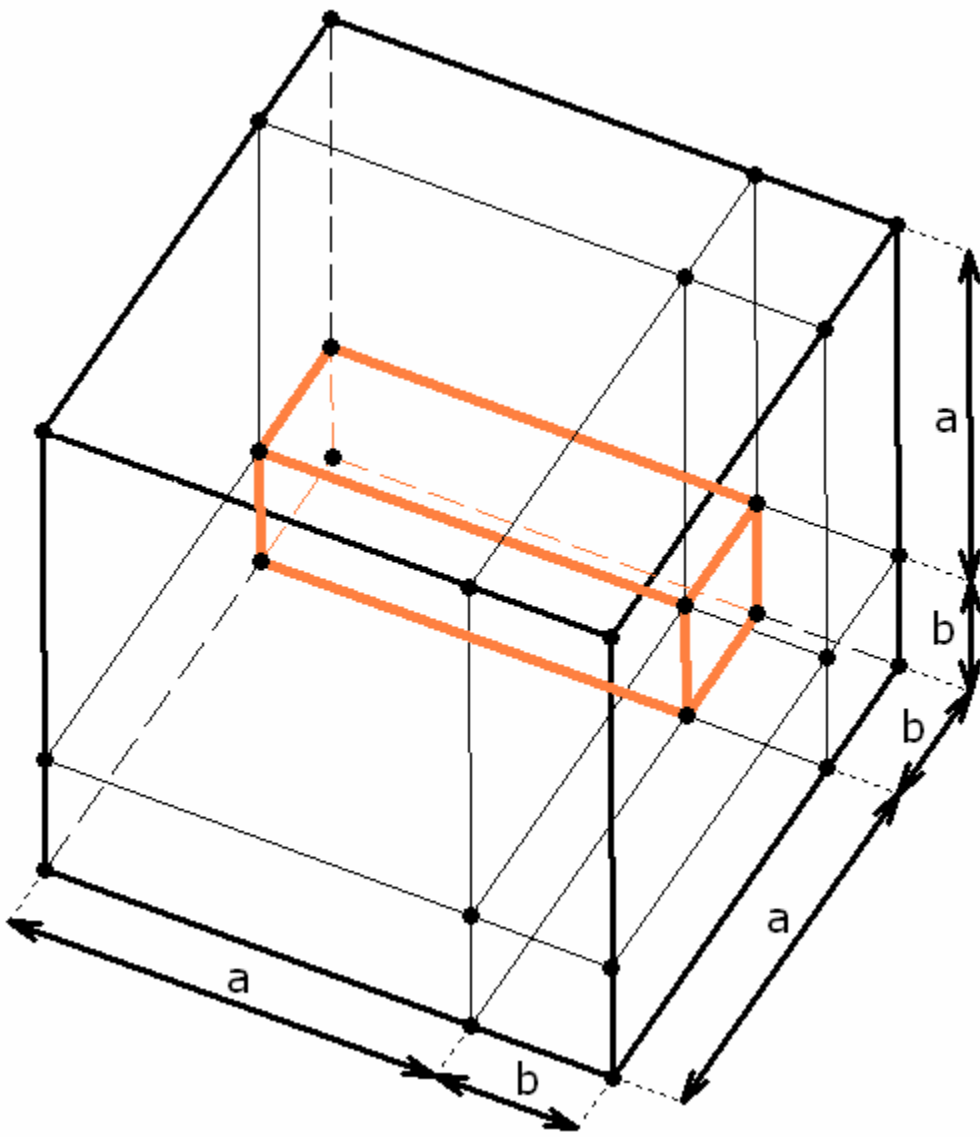

$$+ a^2 b$$

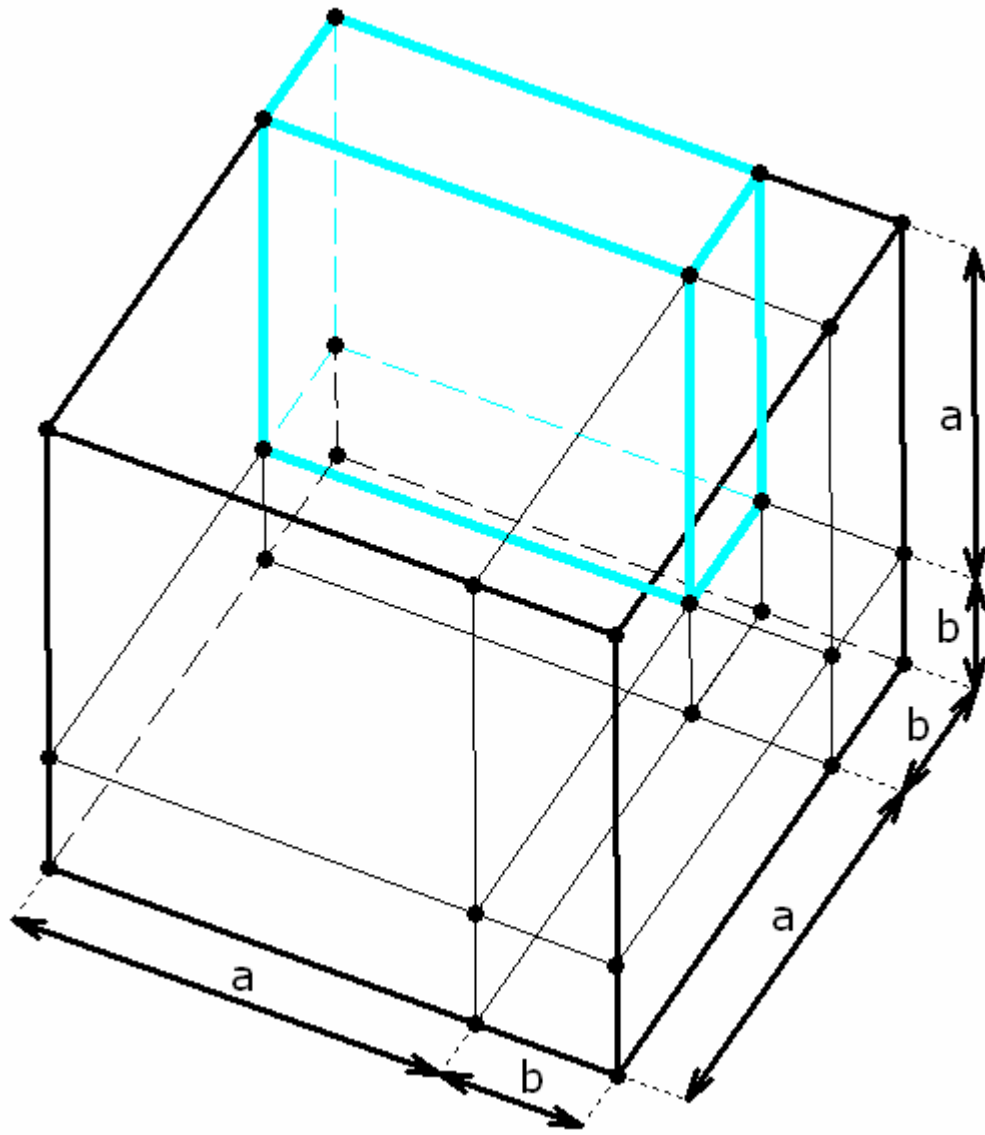

$$+ a^2 b$$

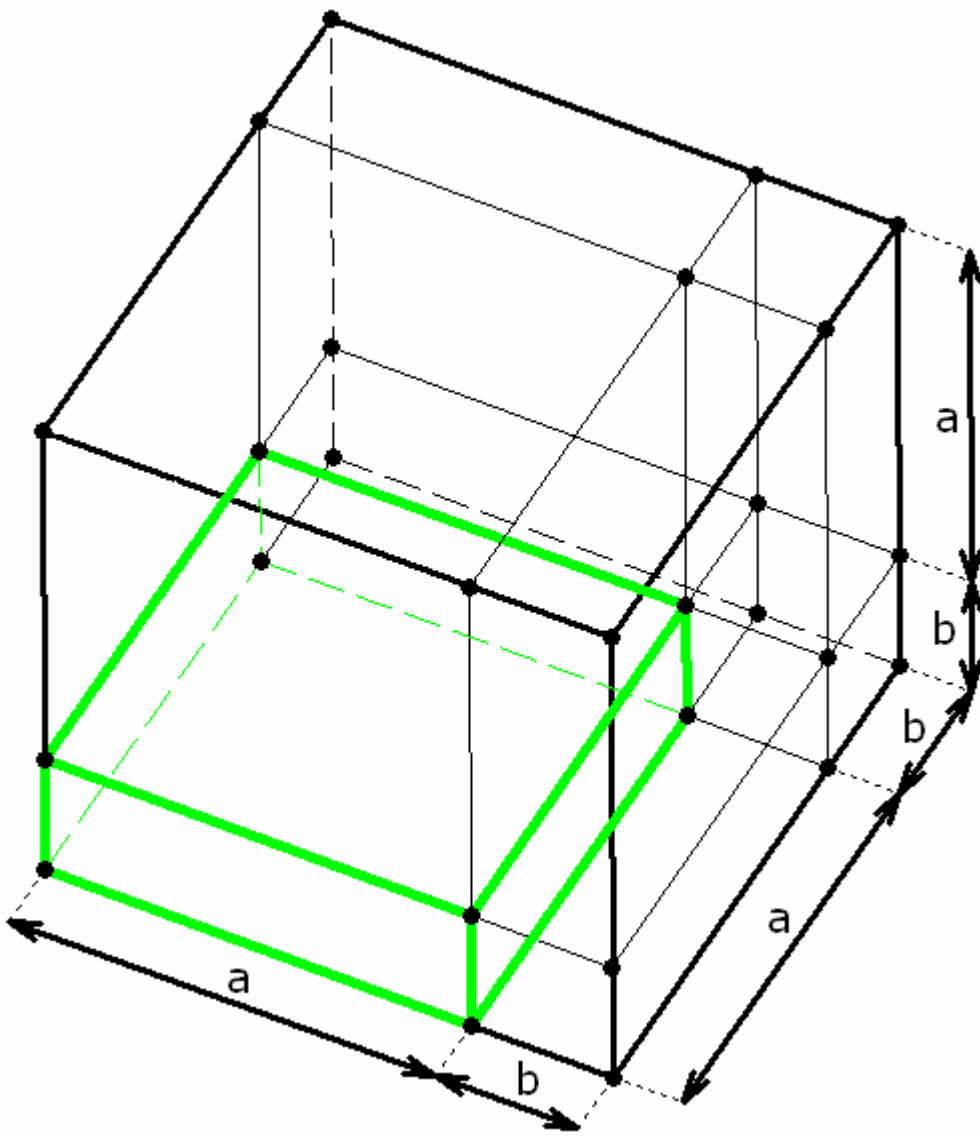

$$+ a^2 b$$

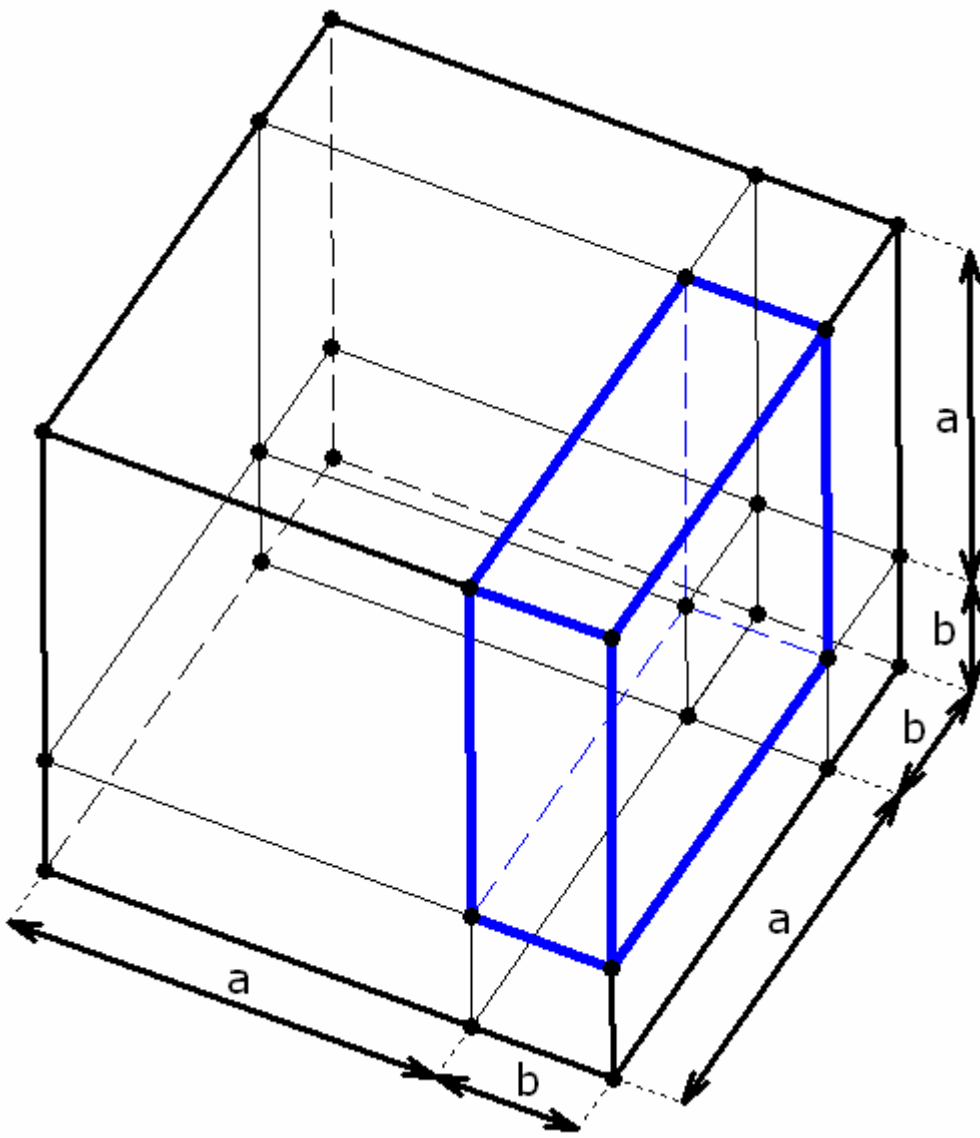

$$+ a^3$$

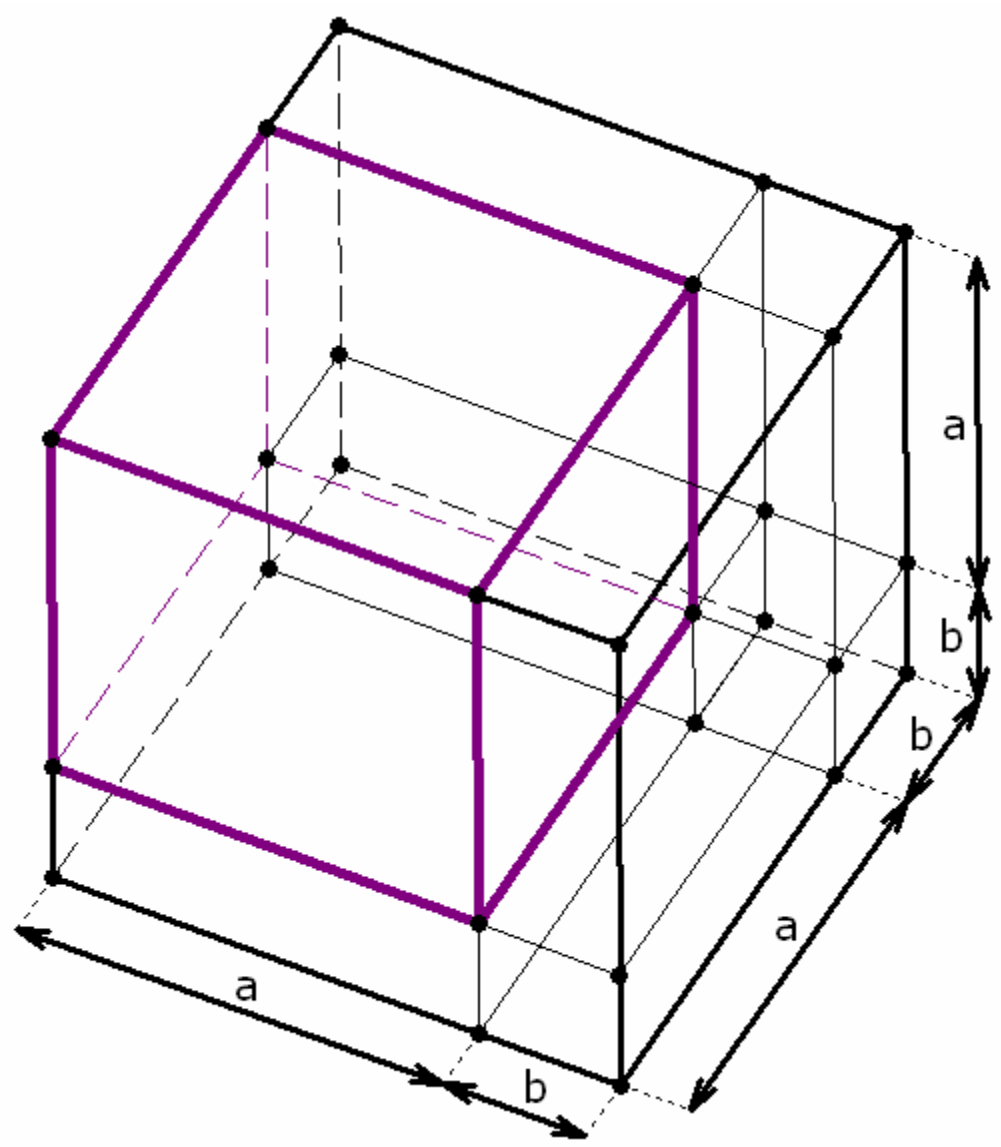

b^3

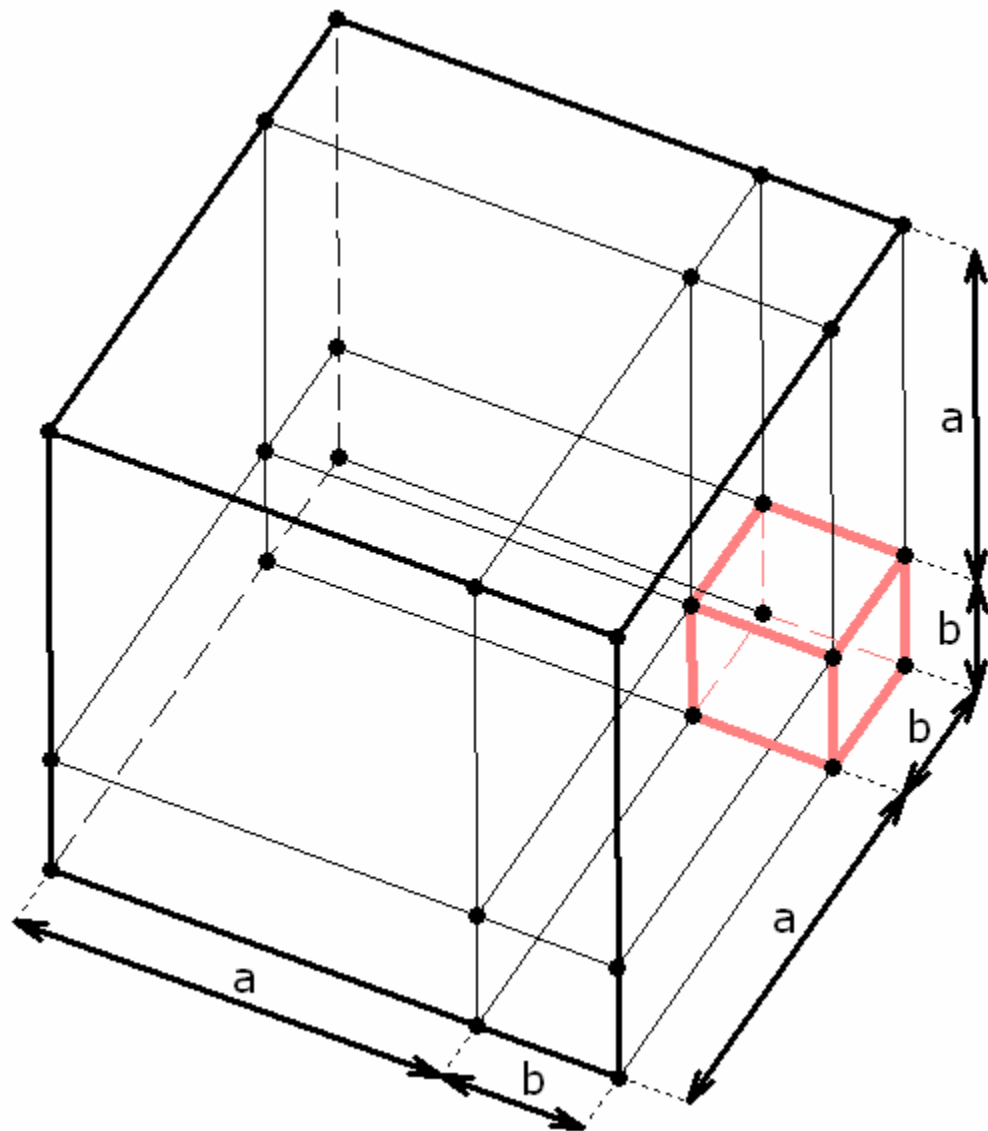

$$+ ab^2$$

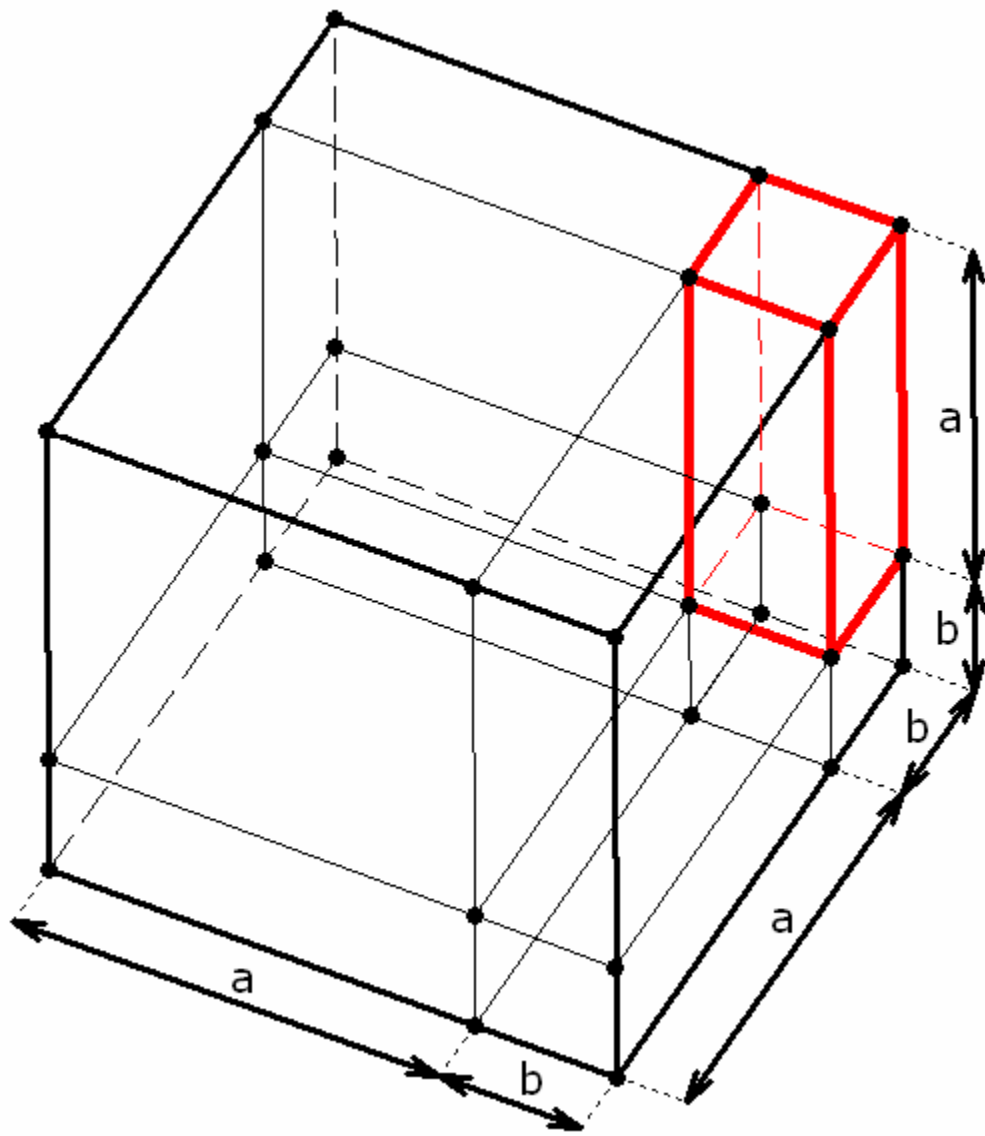

$$+ ab^2$$

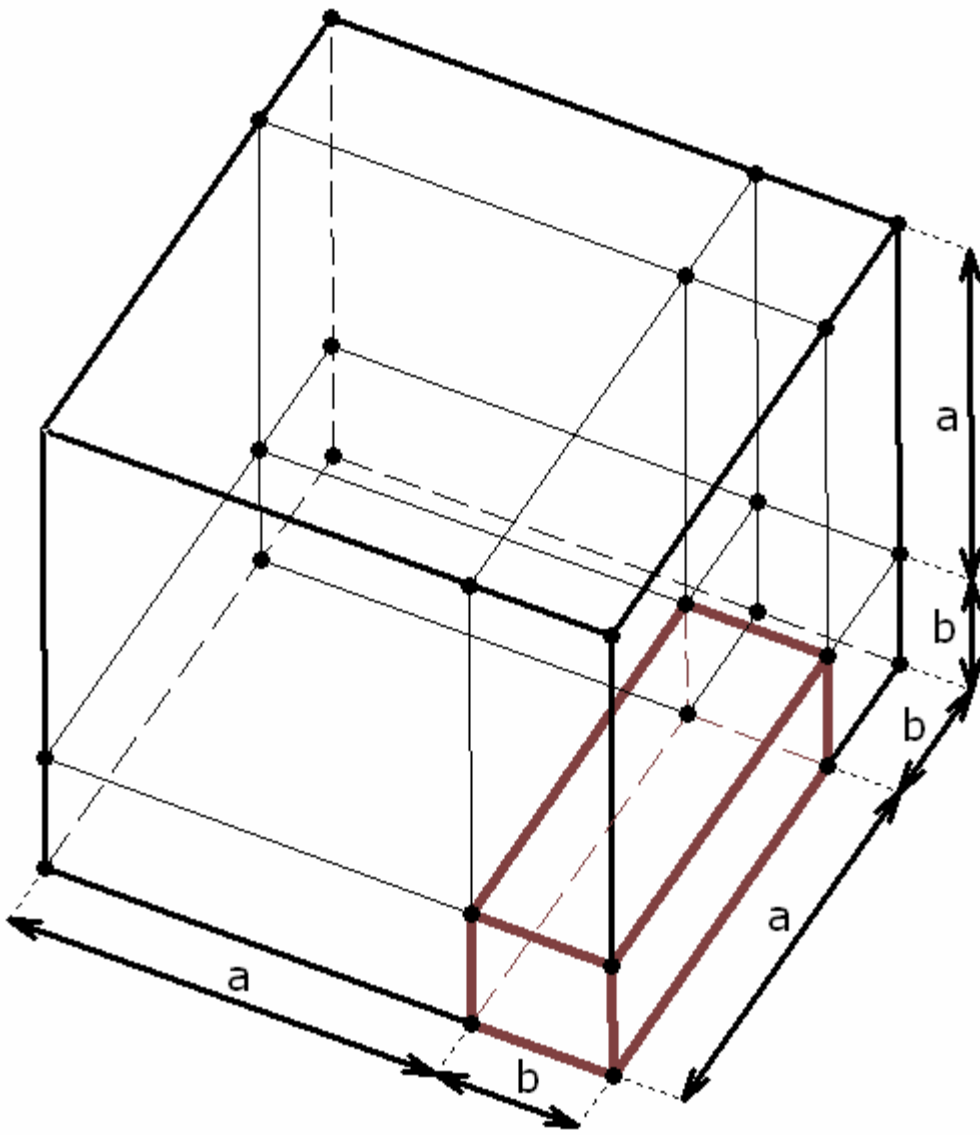

$$+ ab^2$$

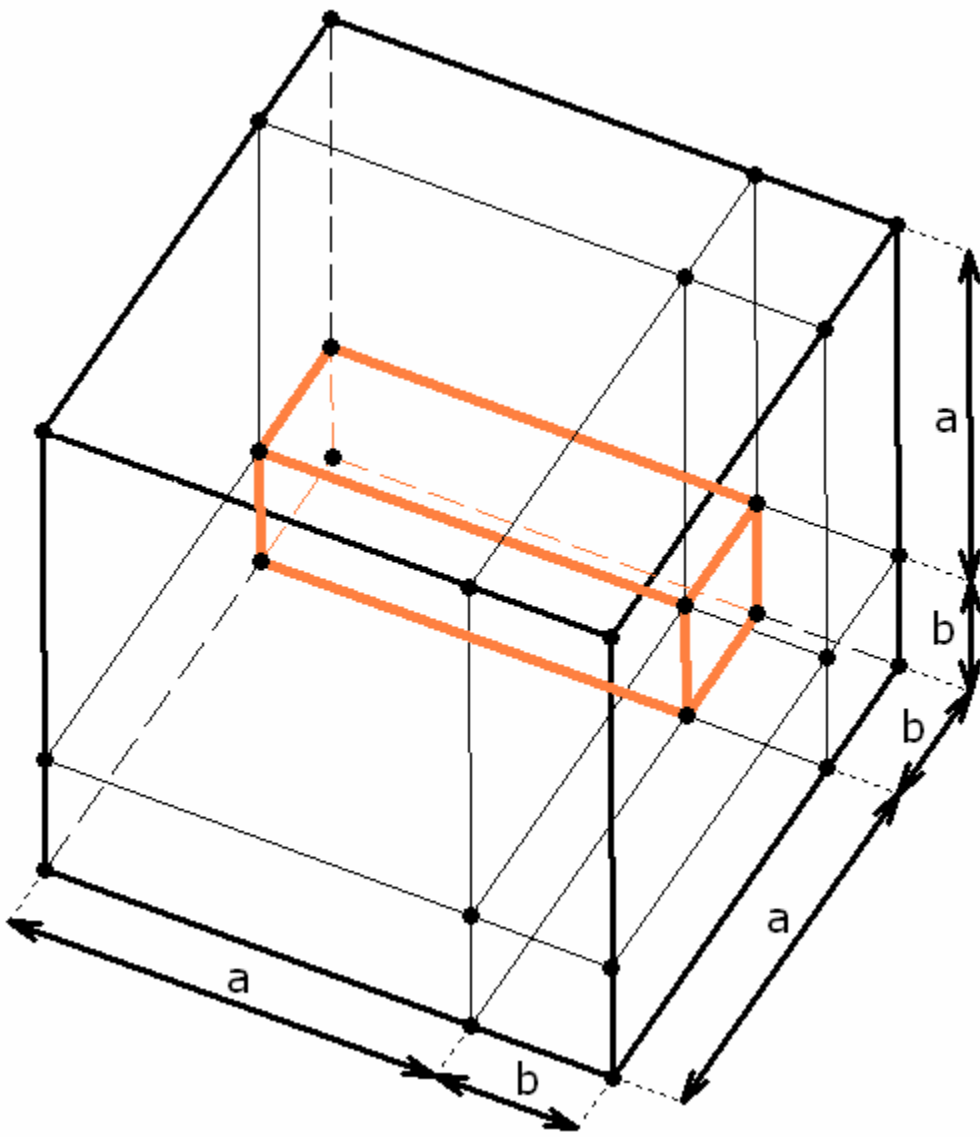

$$+ a^2 b$$

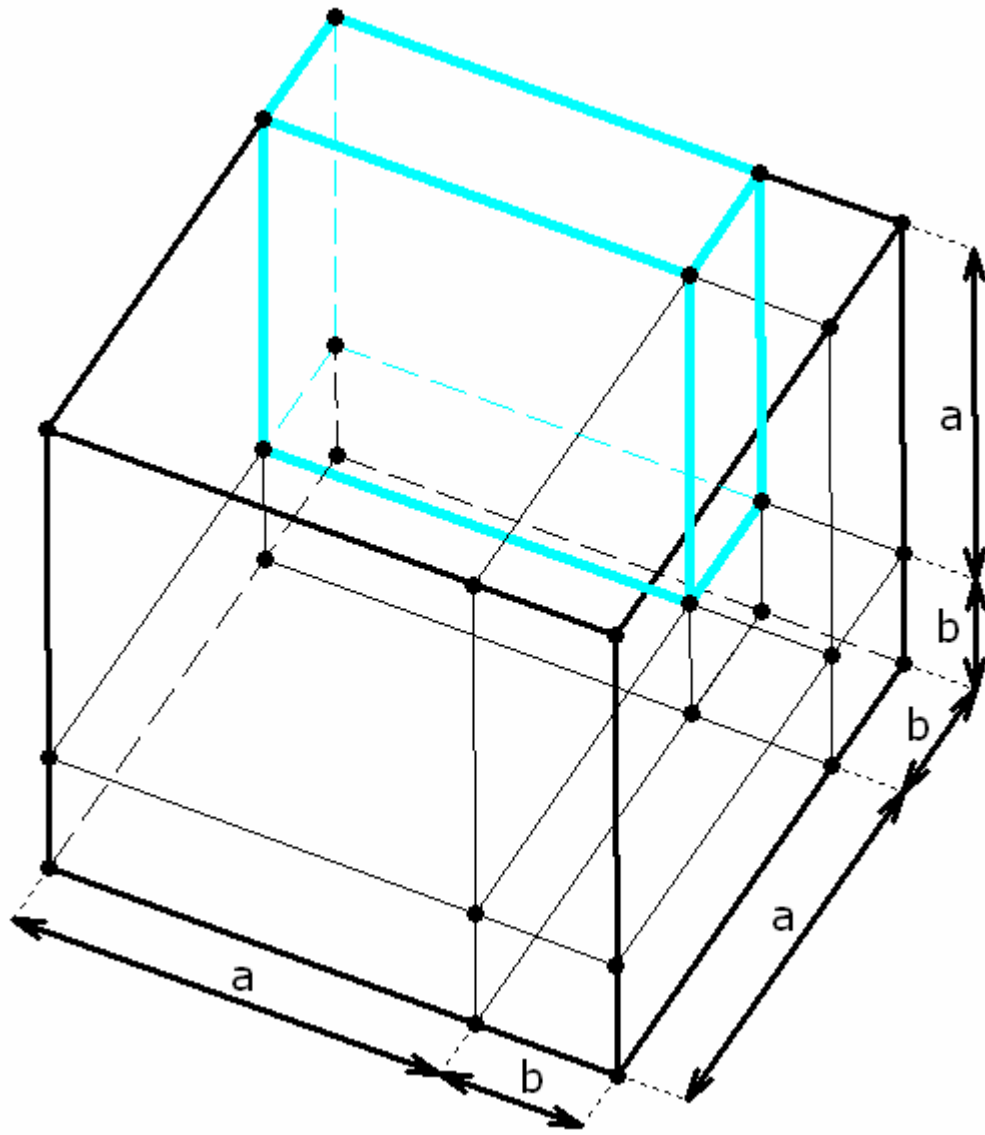

$$+ a^2 b$$

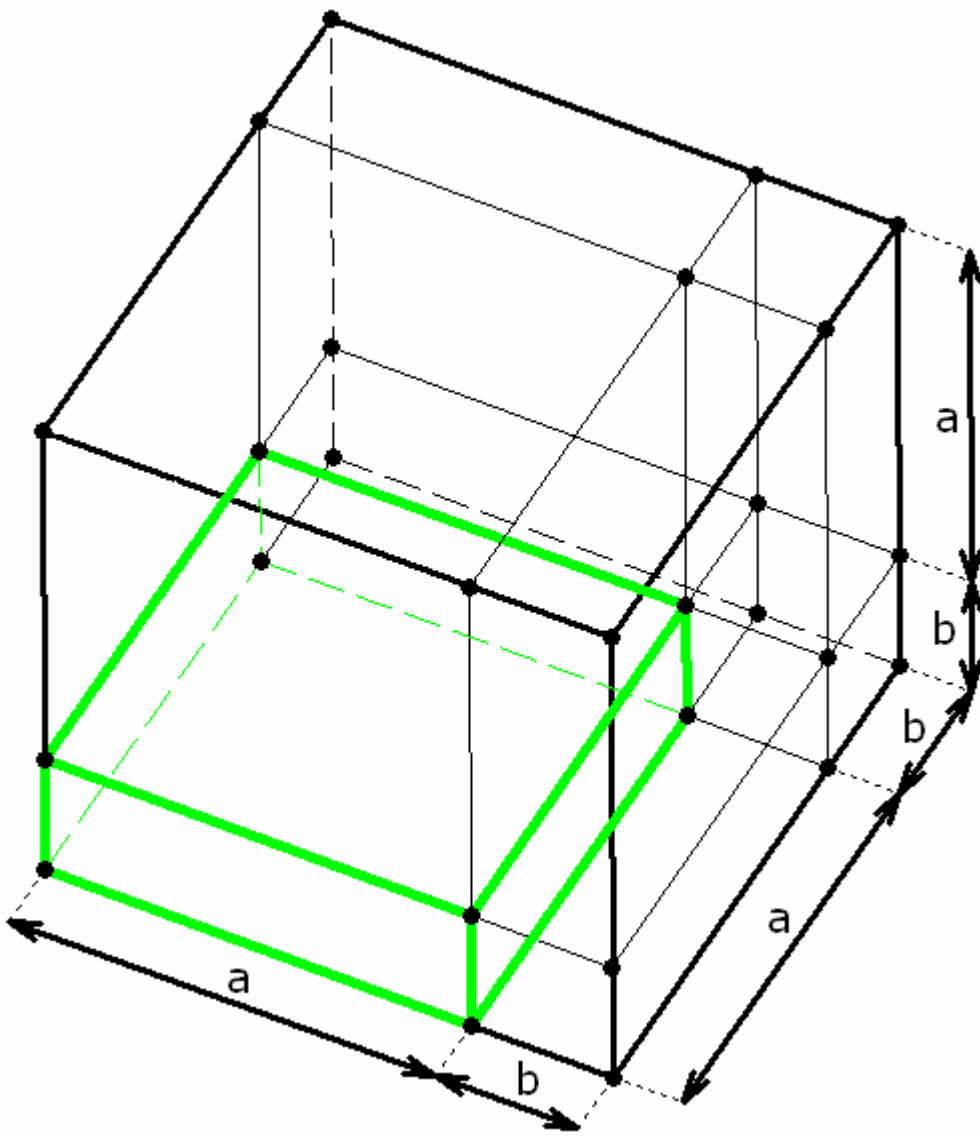

$$+ a^2 b$$

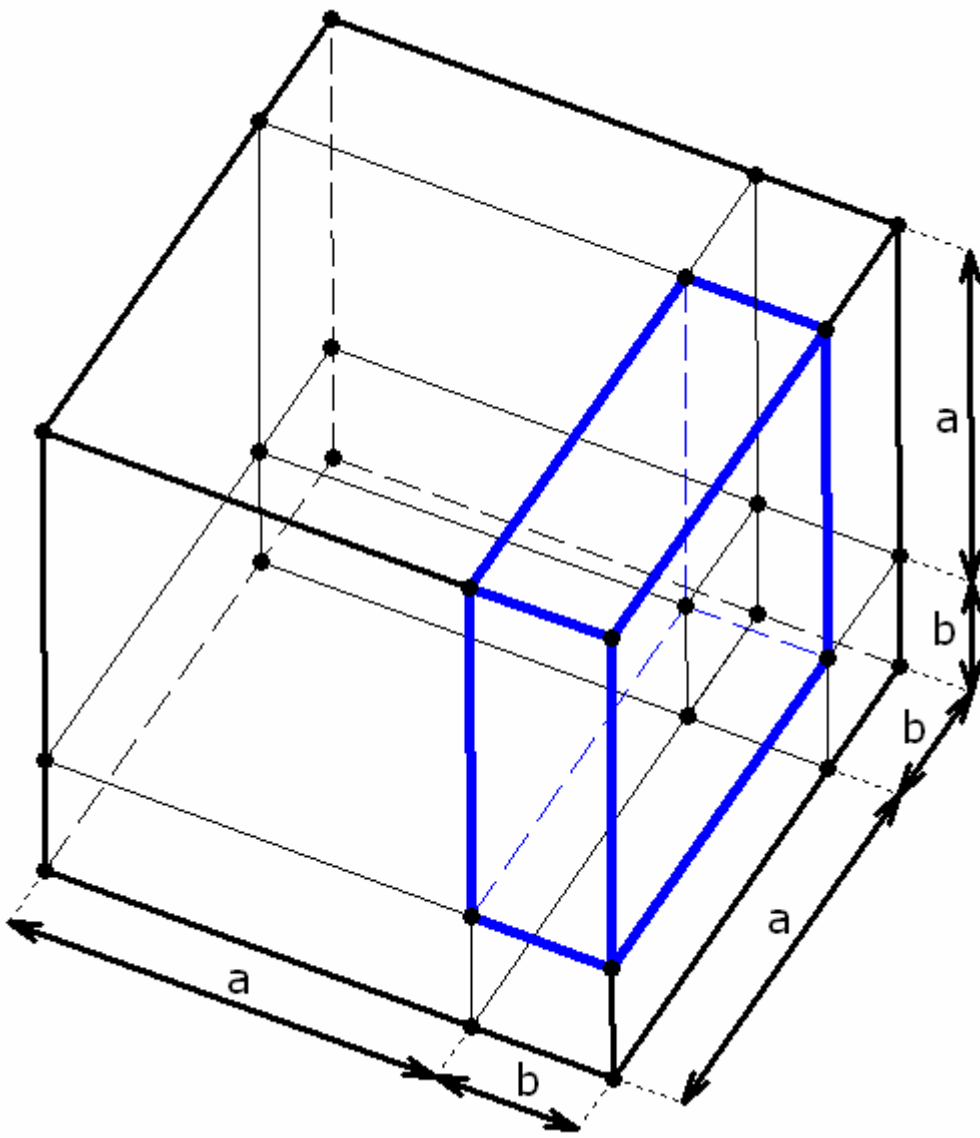

$$+ a^3$$

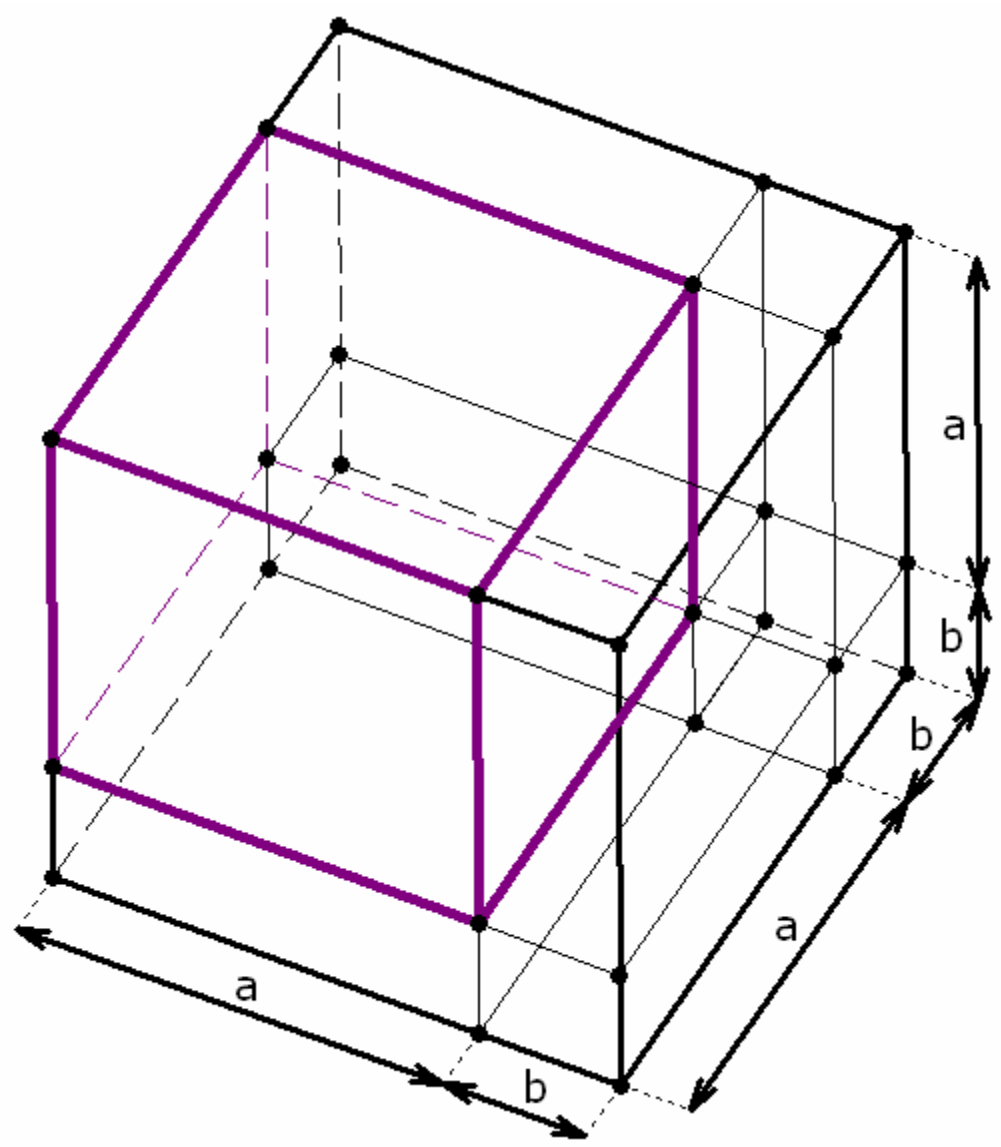

b^3

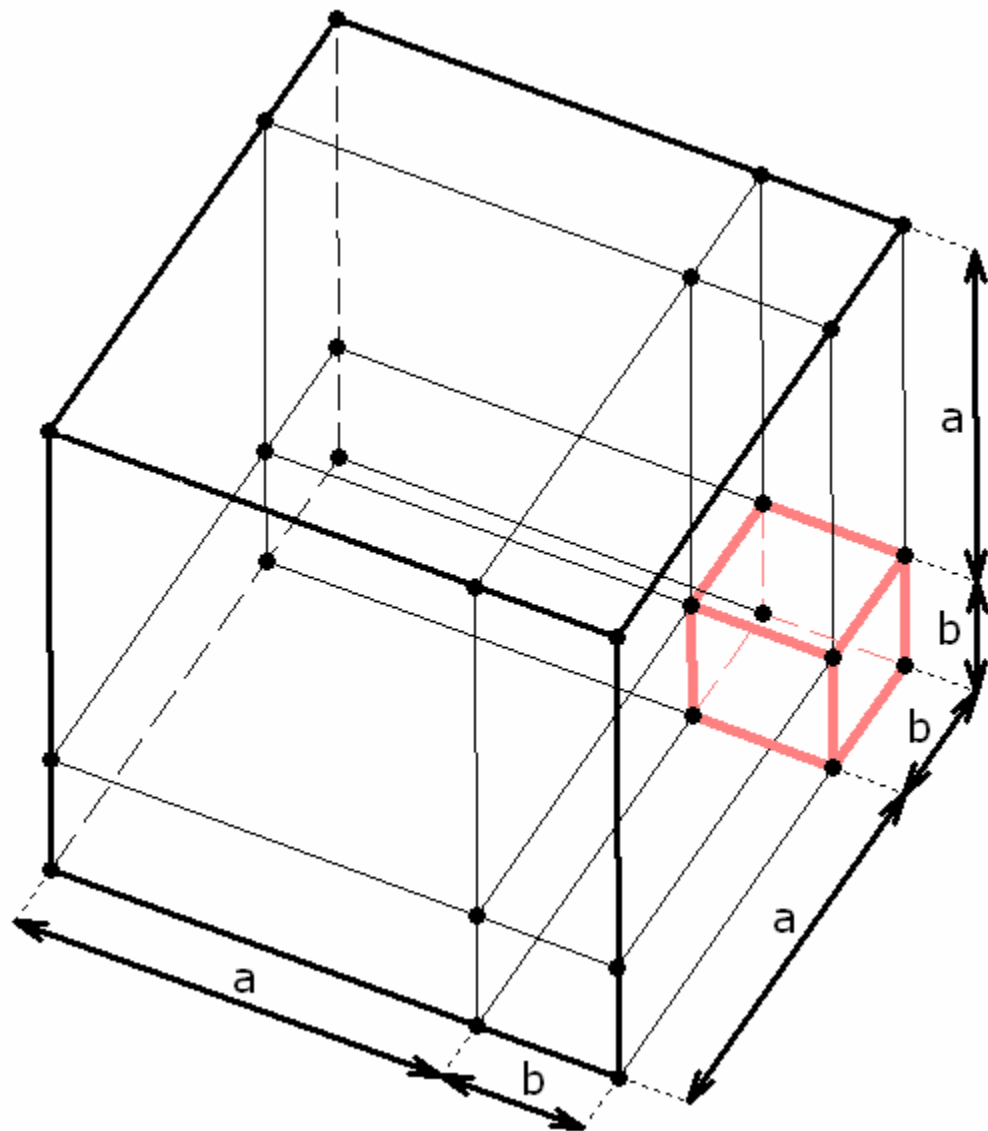

$$+ ab^2$$

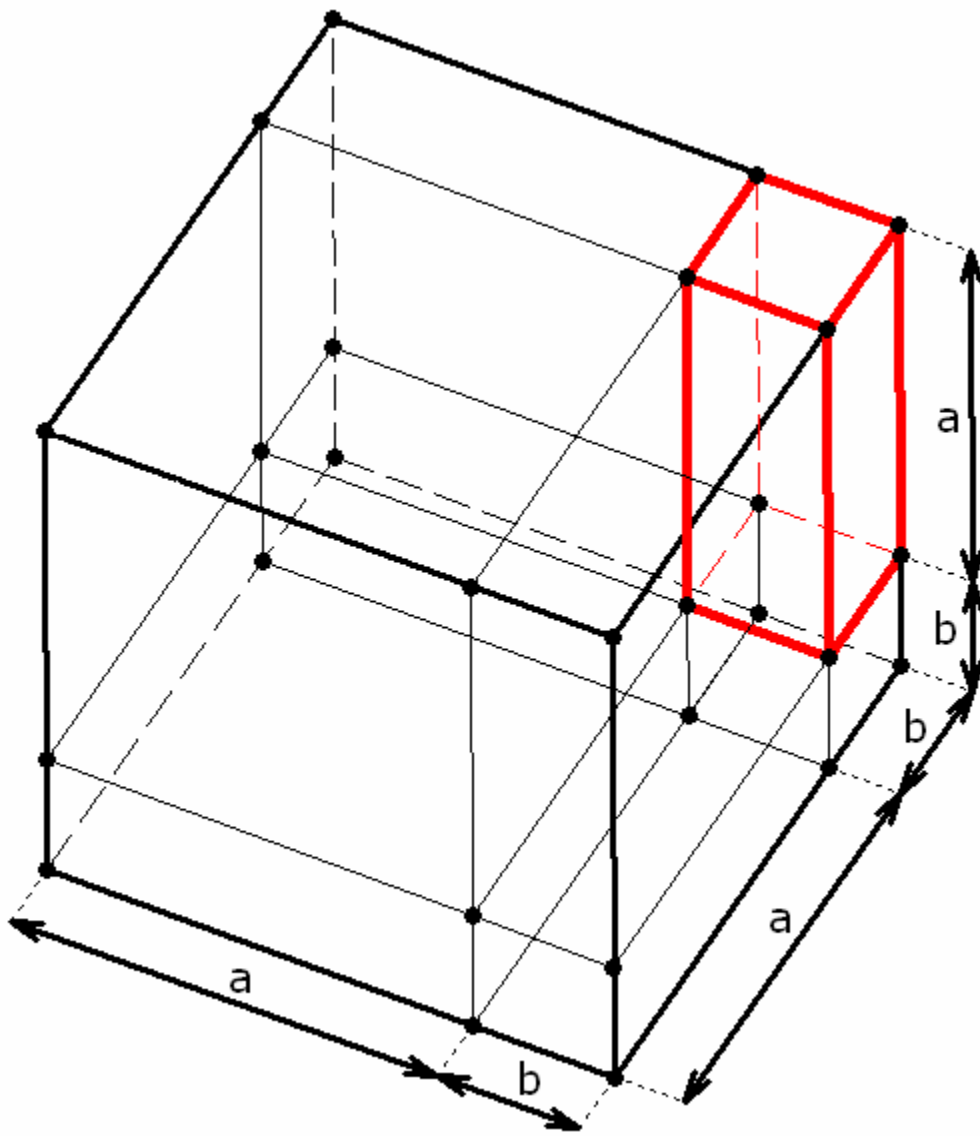

$$+ ab^2$$

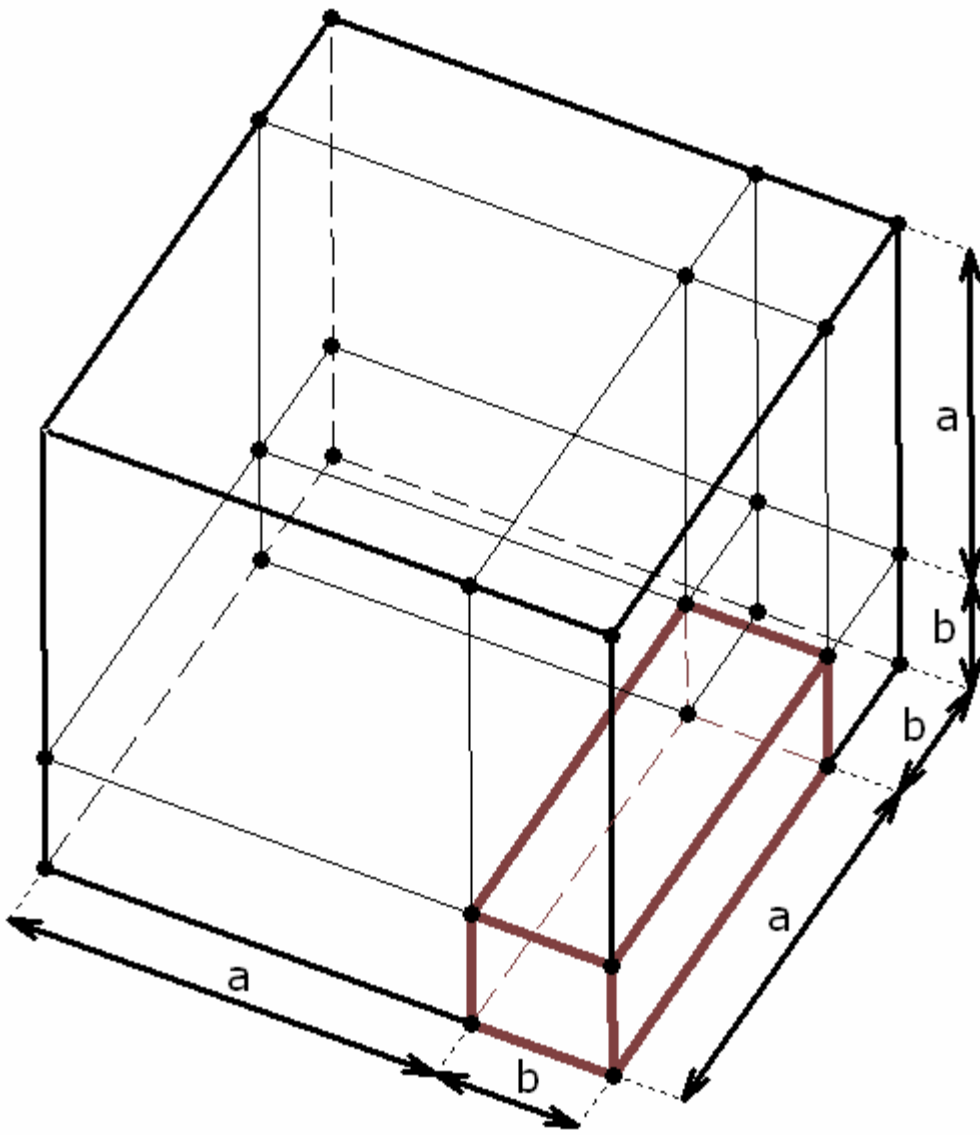

$$+ ab^2$$

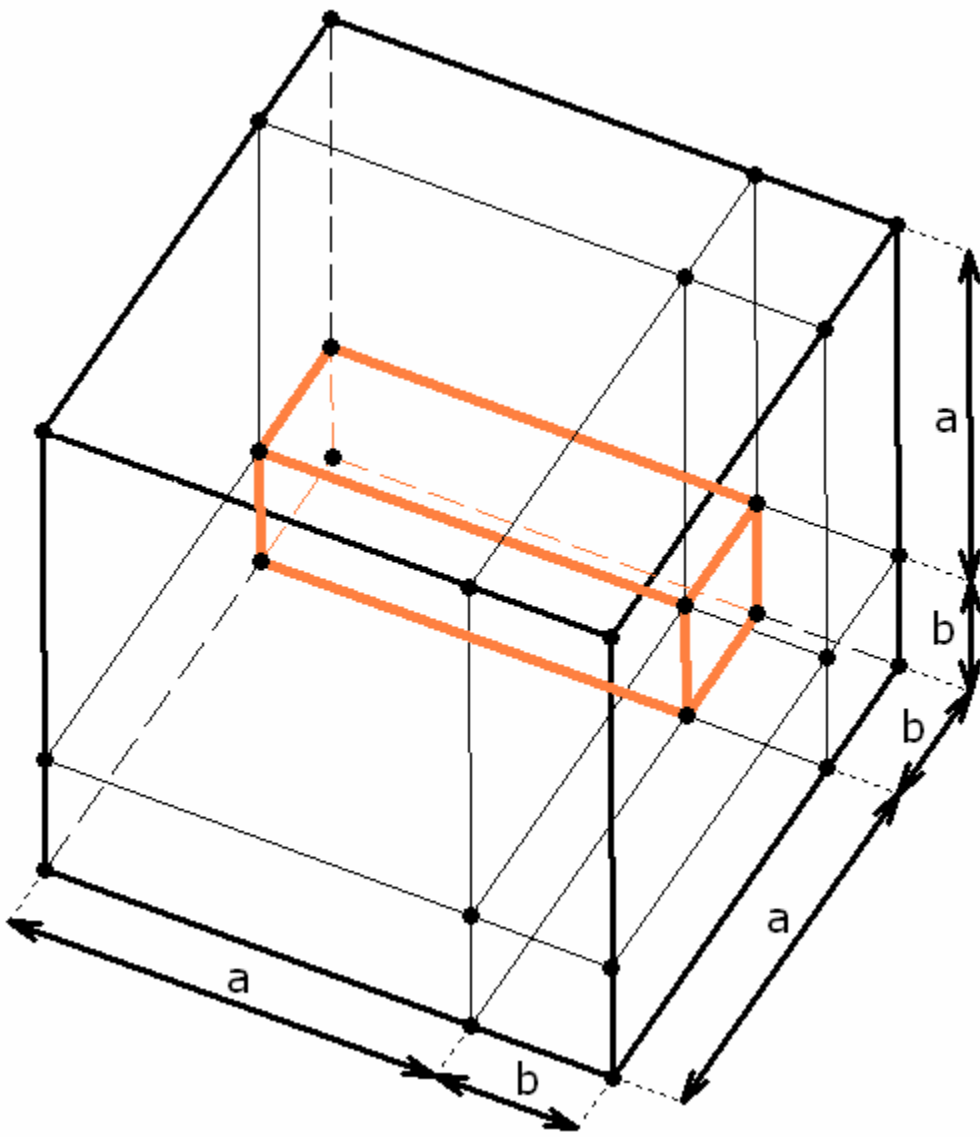

$$+ a^2 b$$

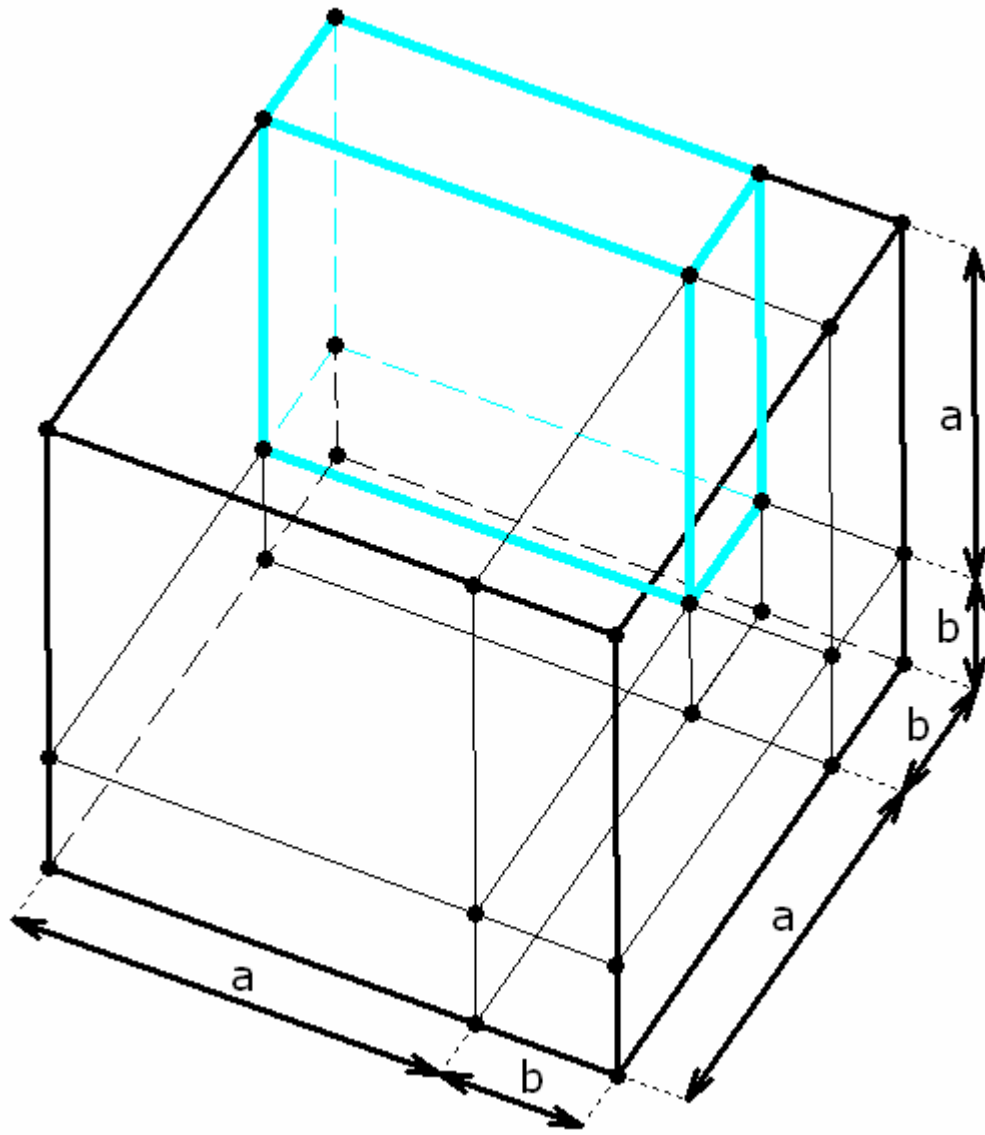

$+ a^2 b$

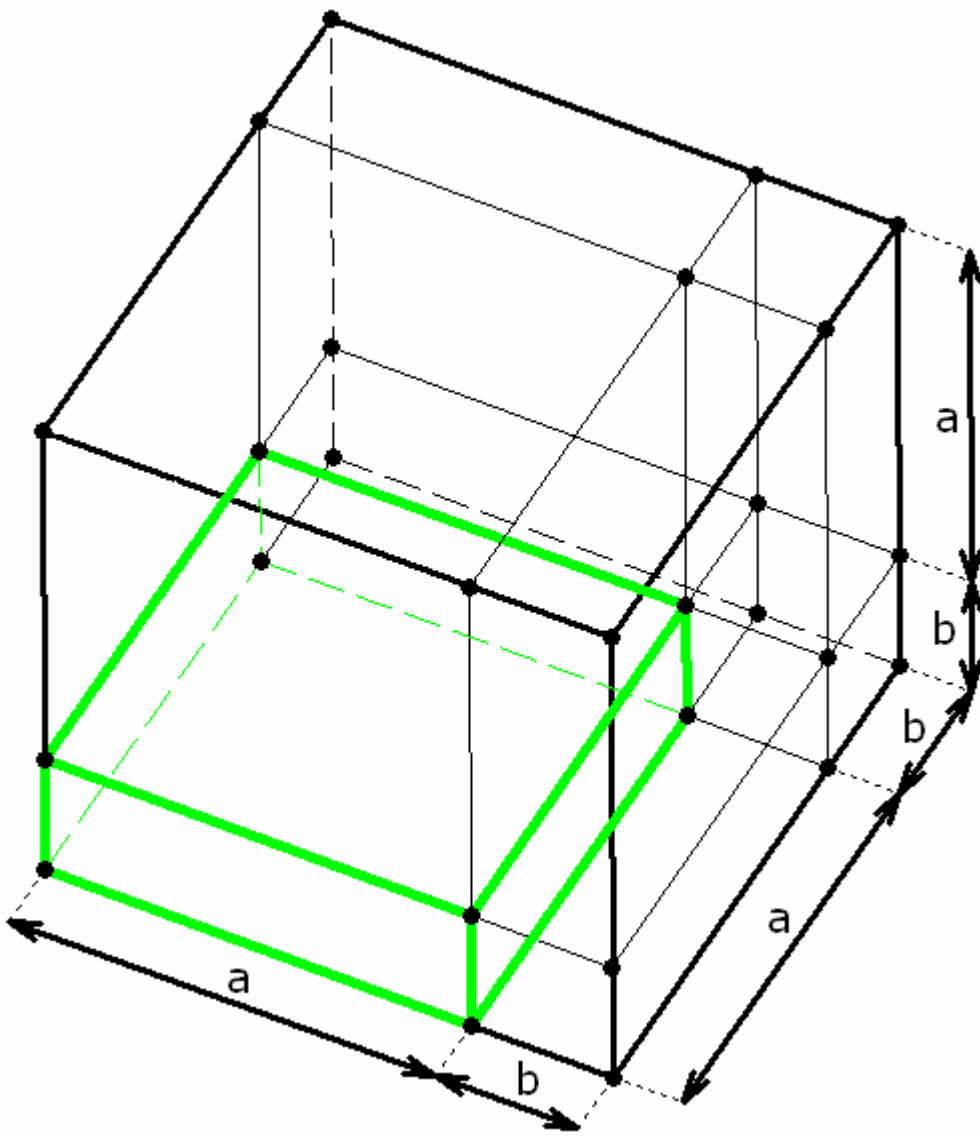

$$+ a^2 b$$

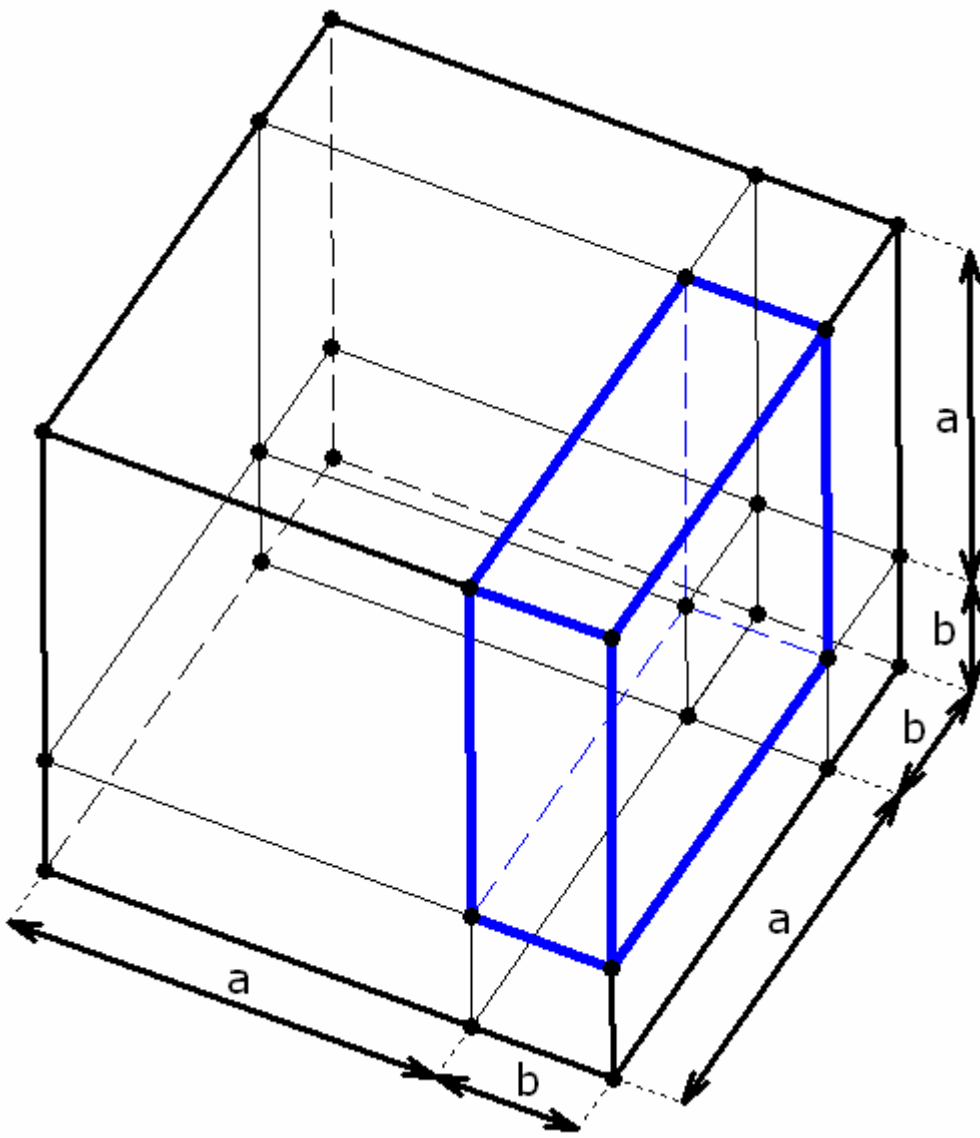

$$+ a^3$$

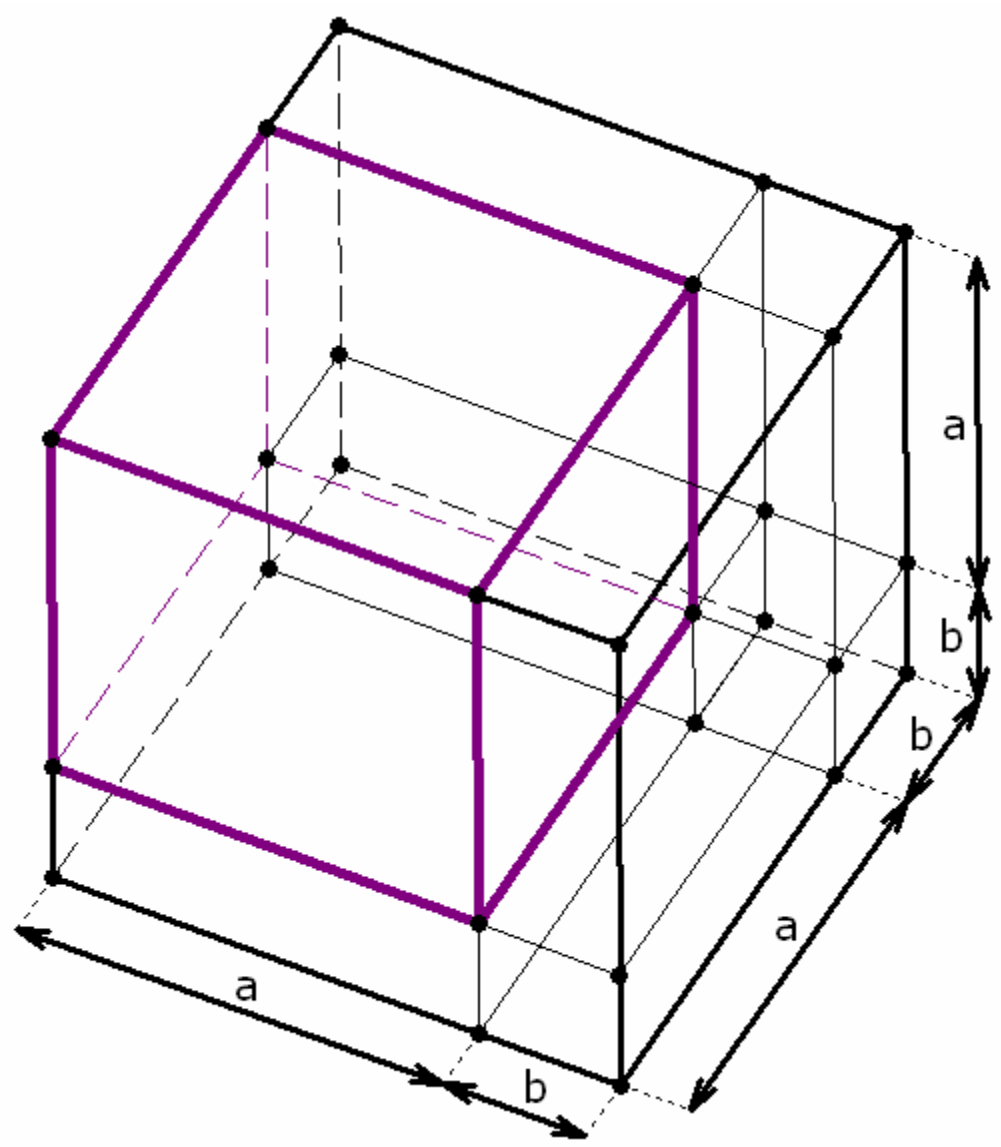

b^3

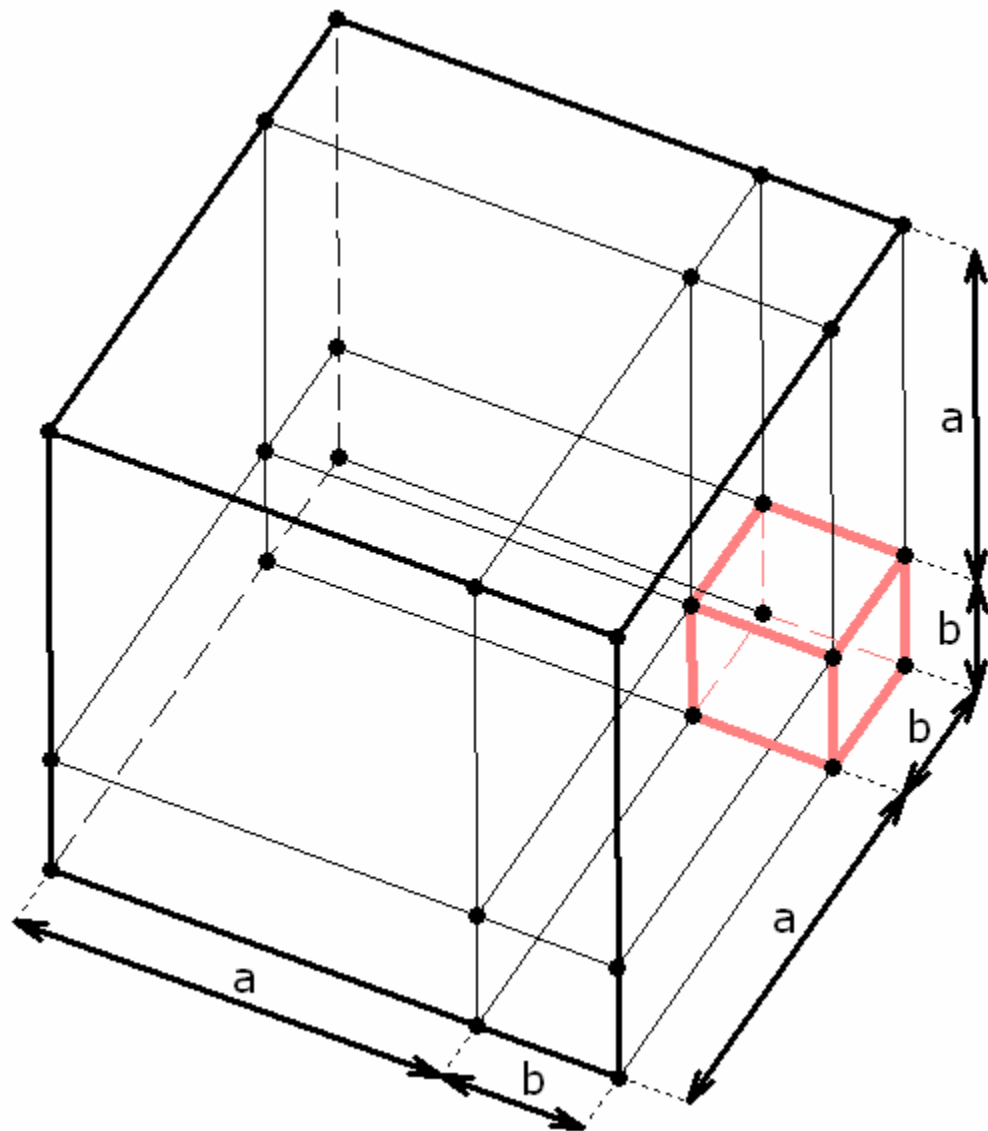

$$+ ab^2$$

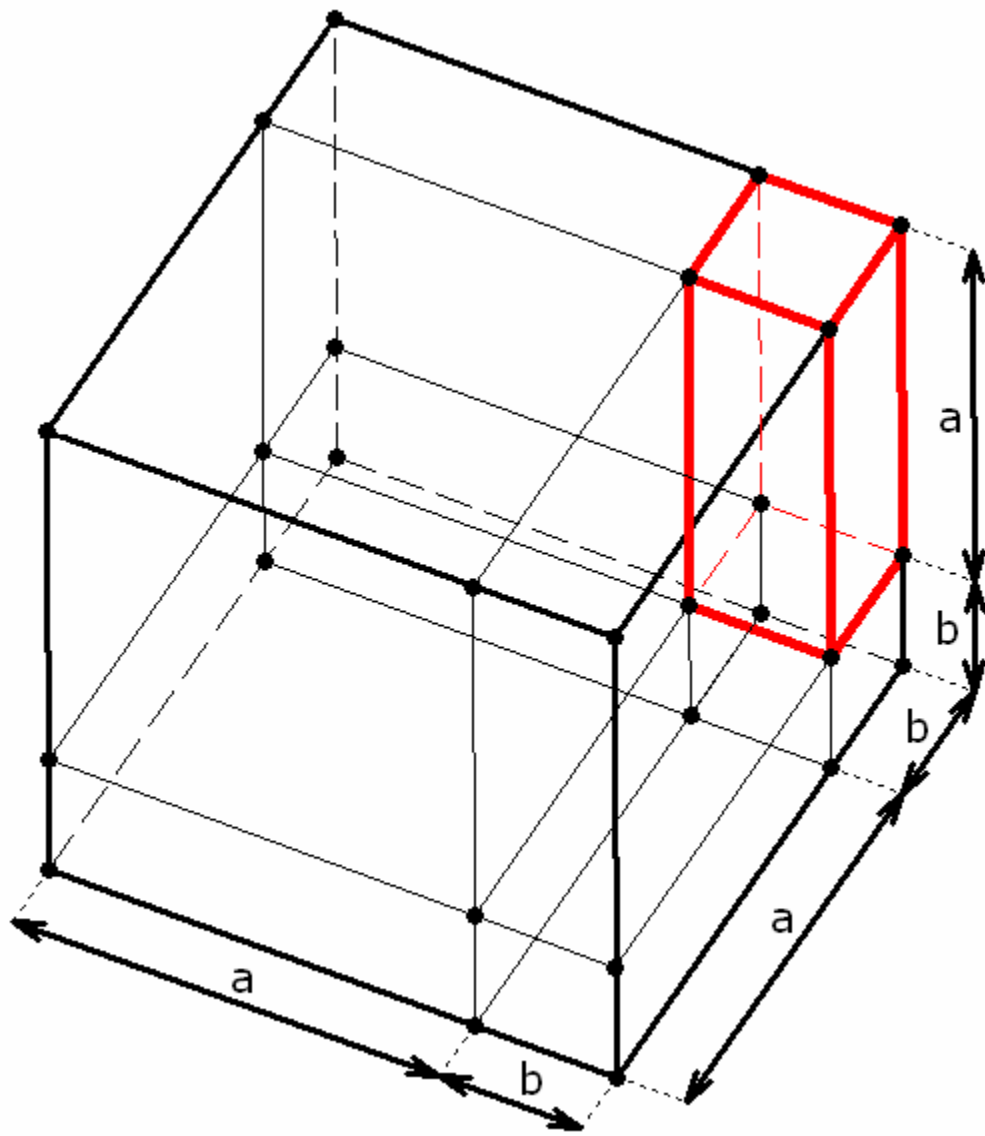

$$+ ab^2$$

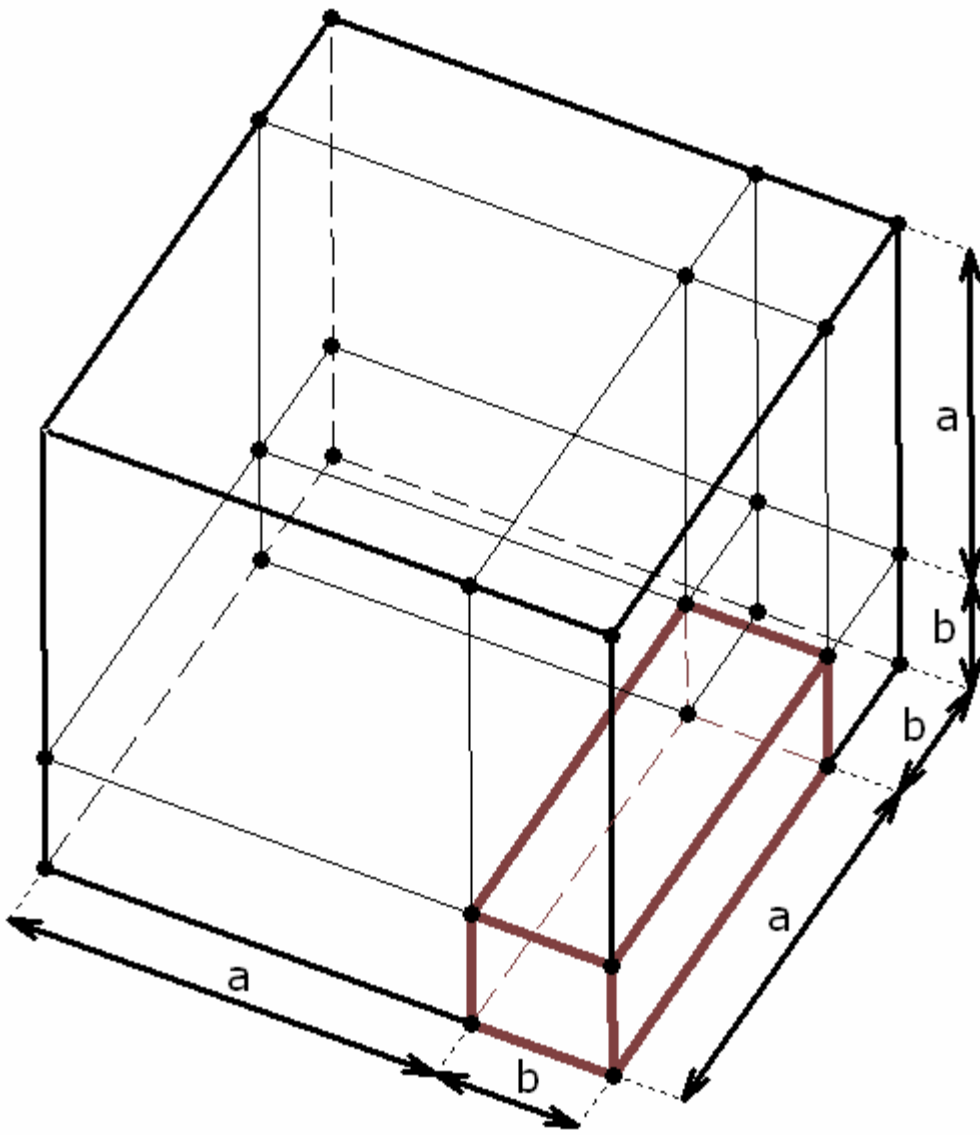

$$+ ab^2$$

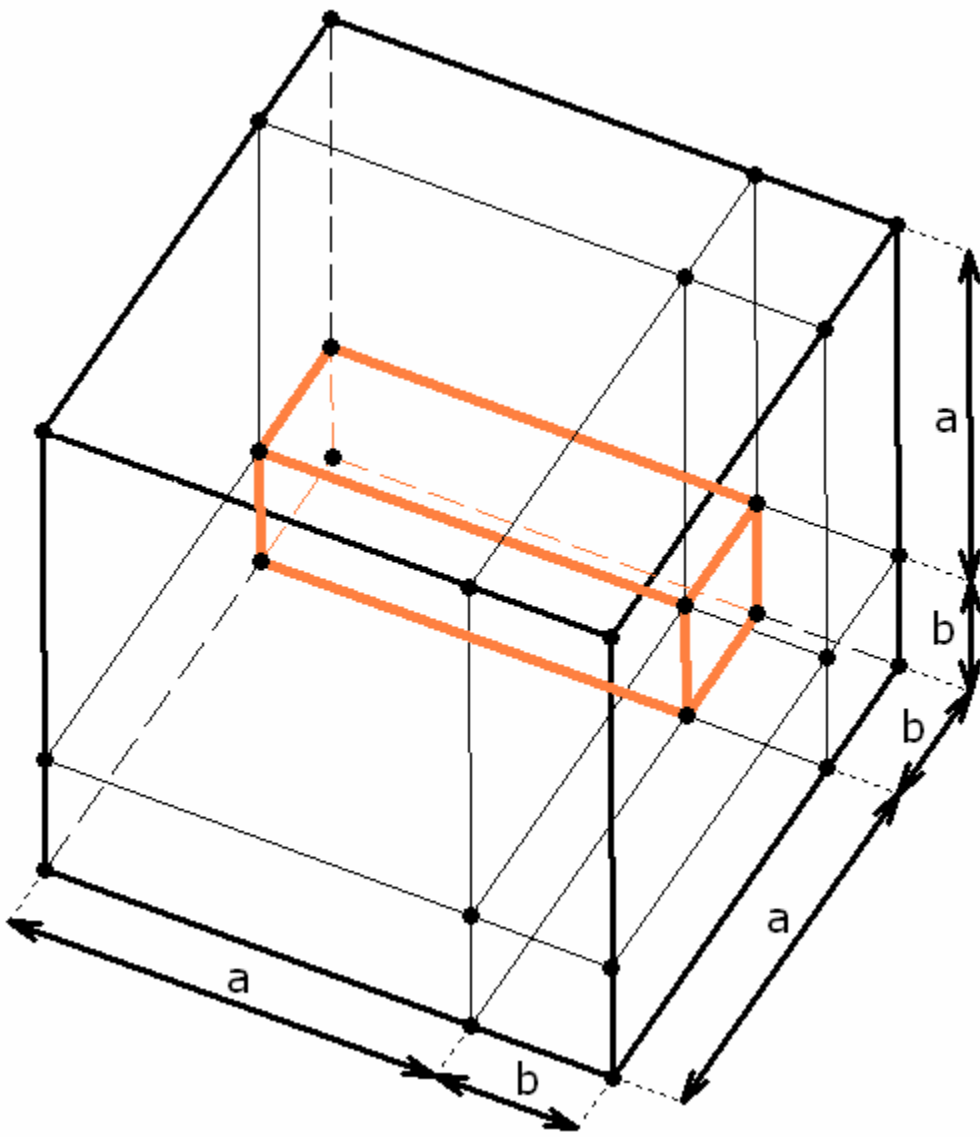

$$+ a^2 b$$

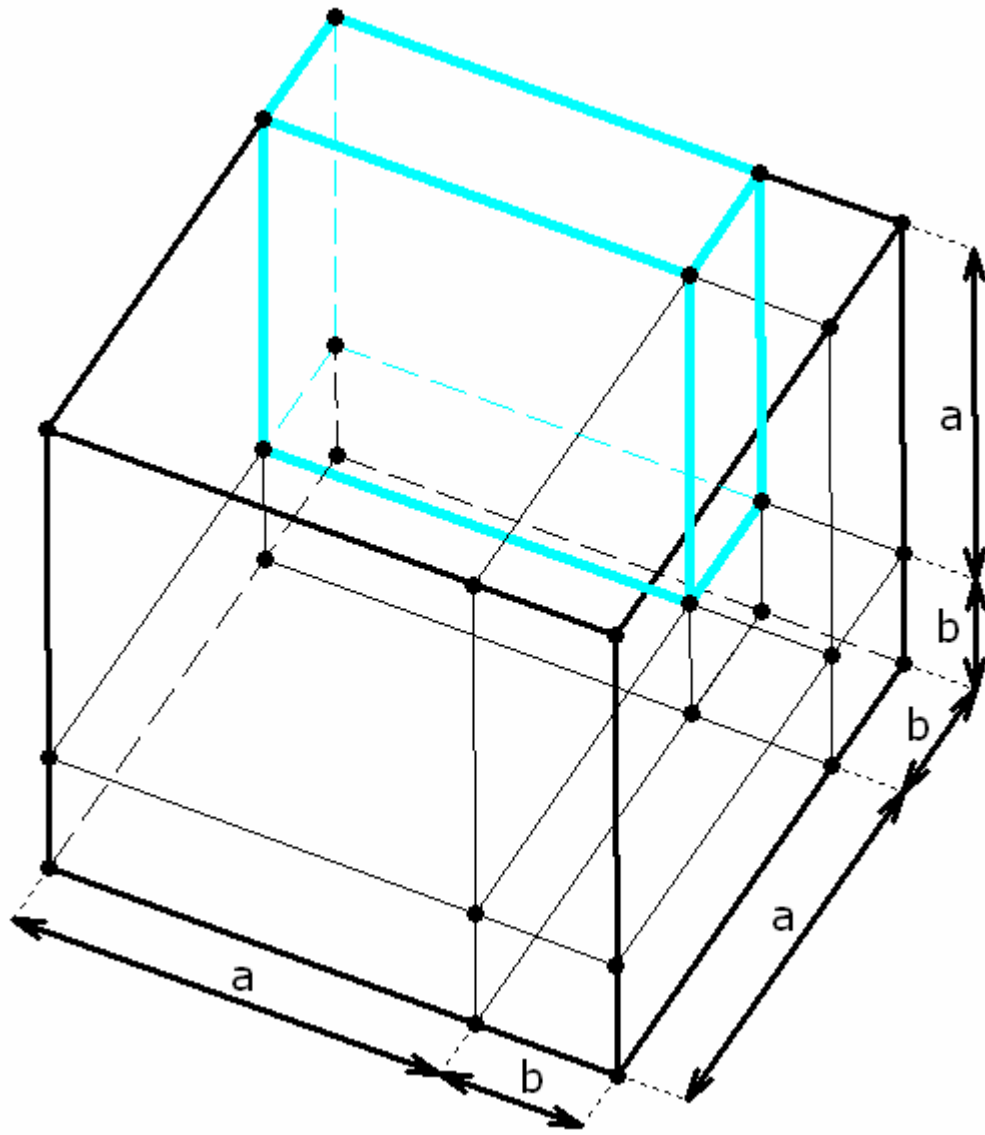

$+ a^2 b$

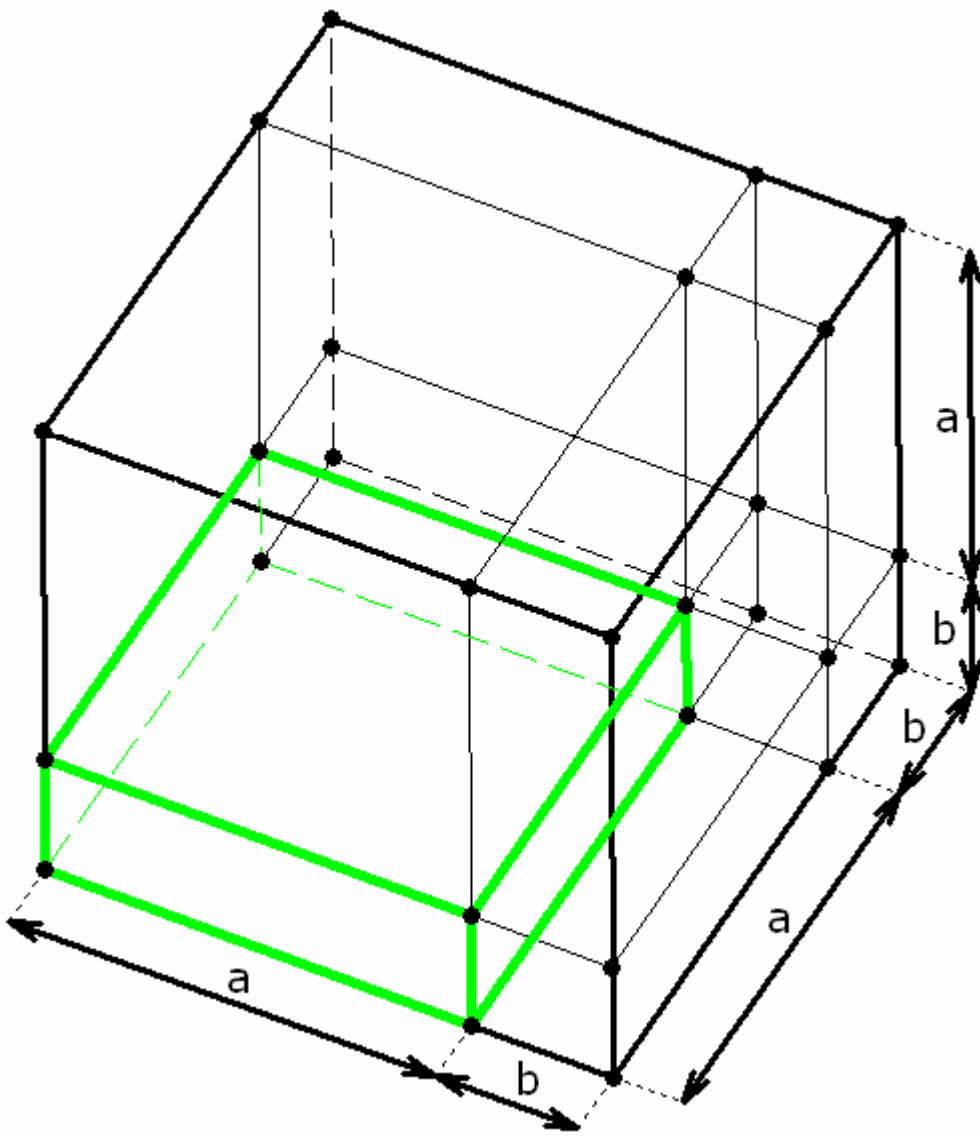

$$+ a^2 b$$

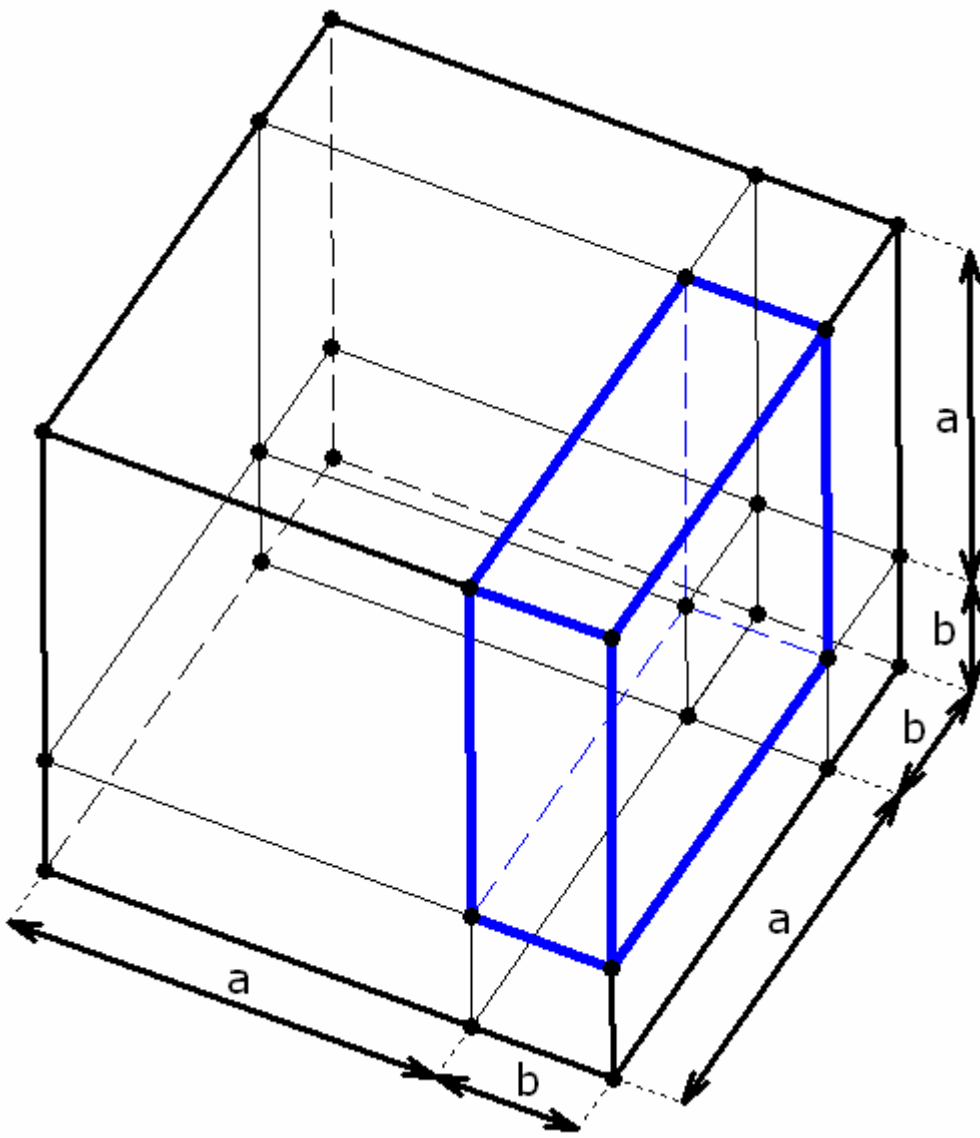

$$+ a^3$$

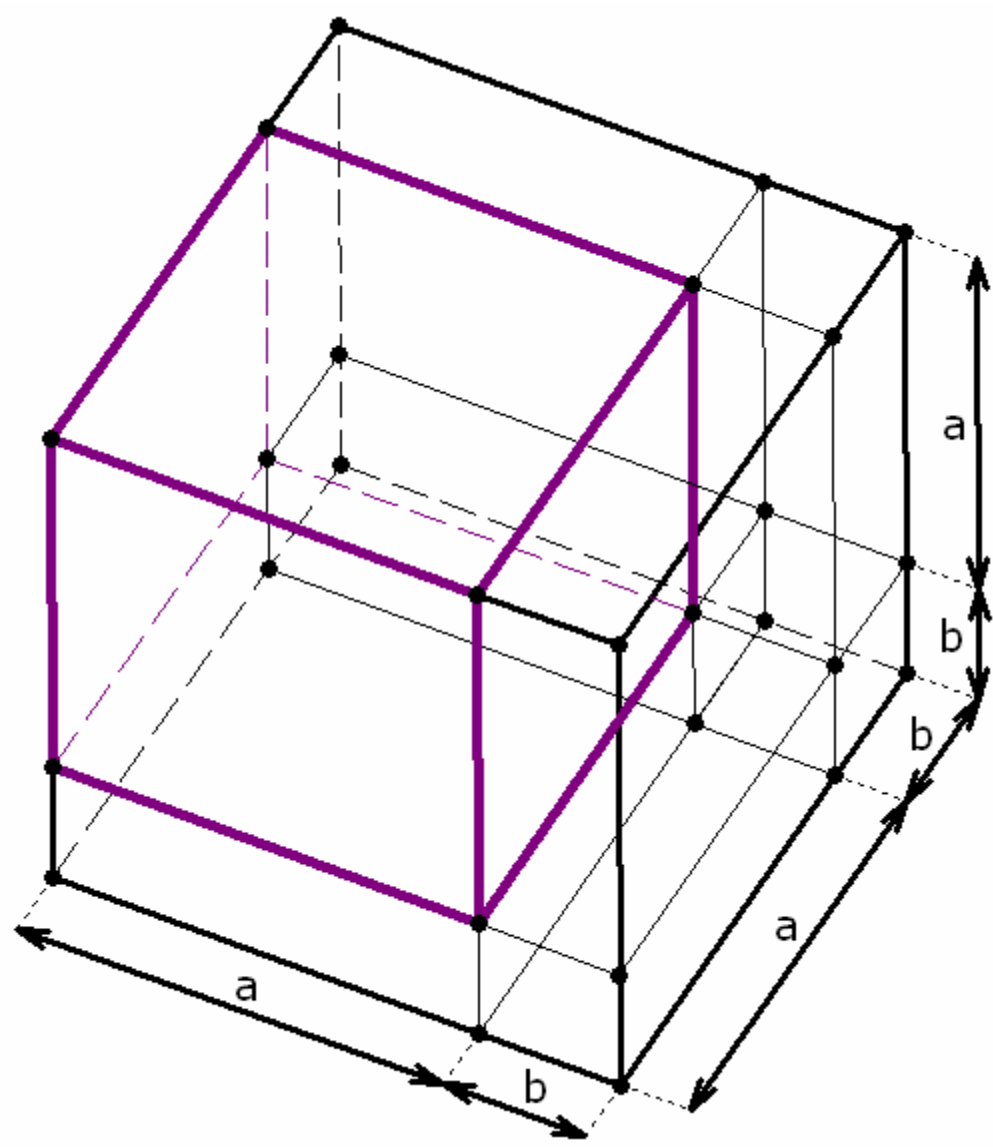

b^3

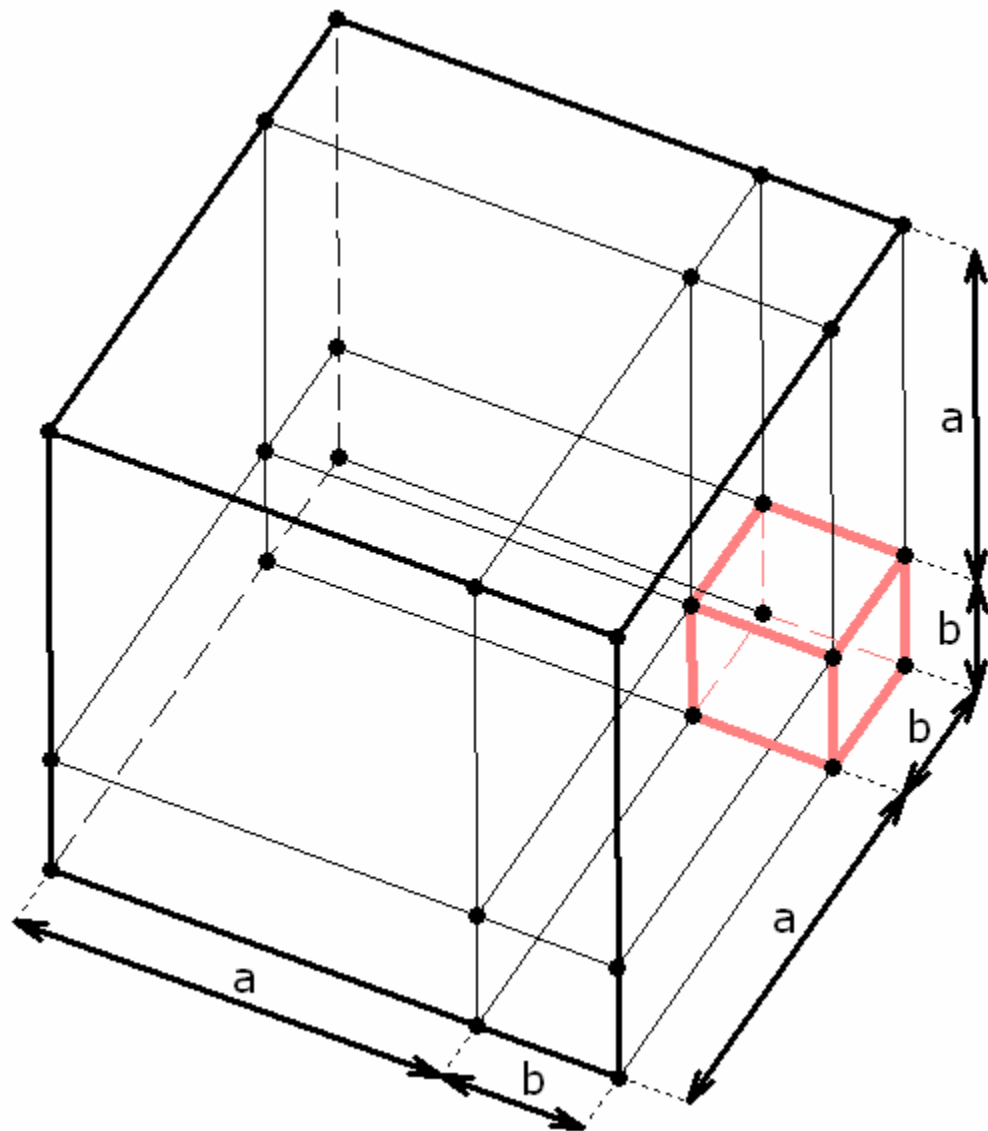

$$+ ab^2$$

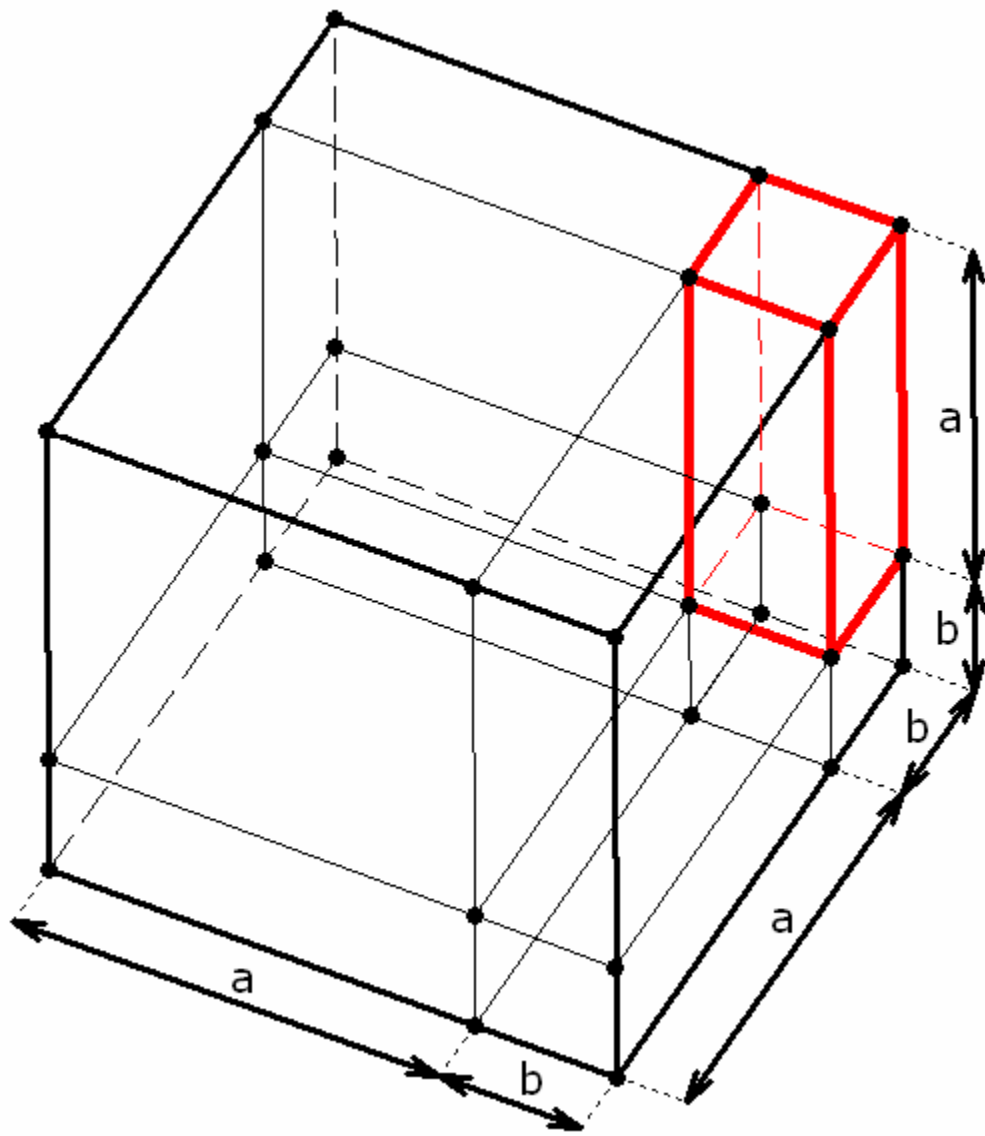

$$+ ab^2$$

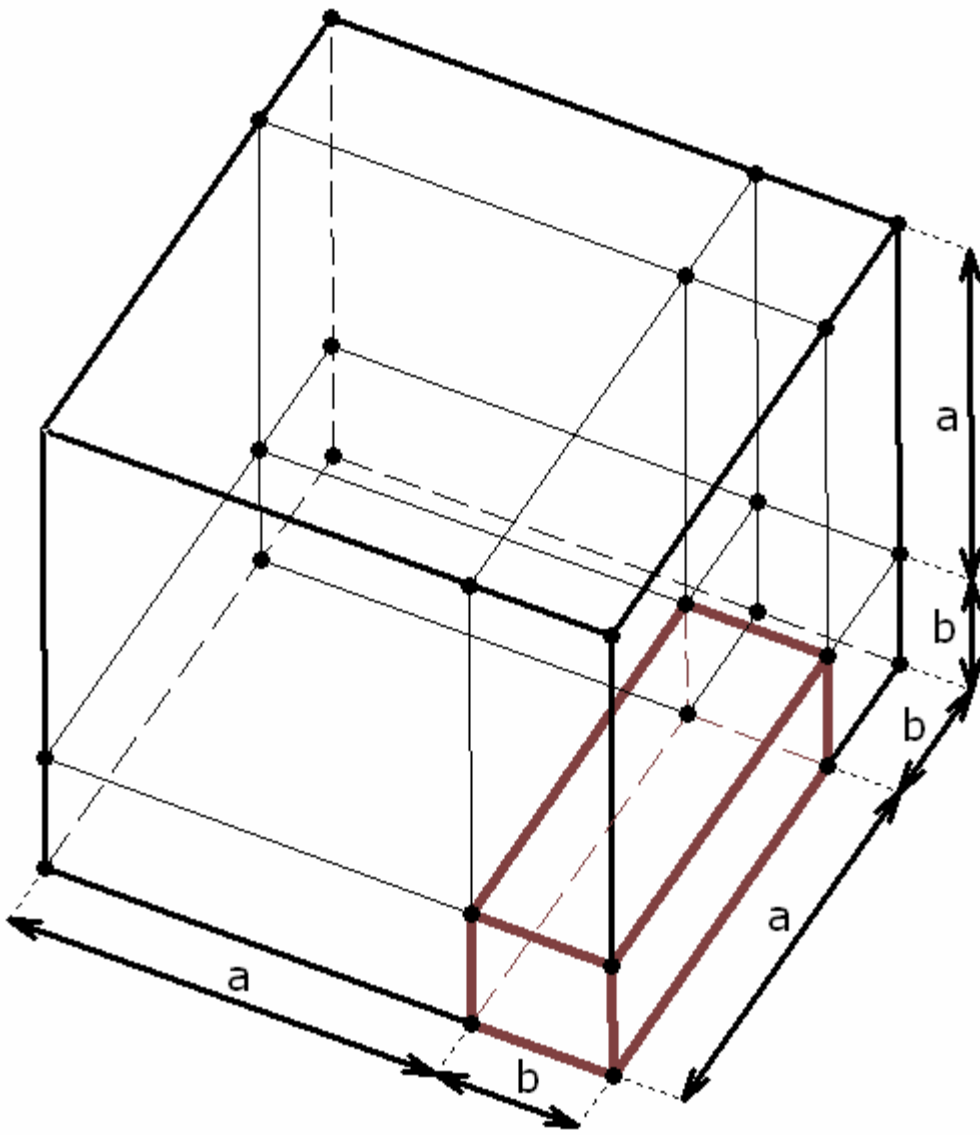

$$+ ab^2$$

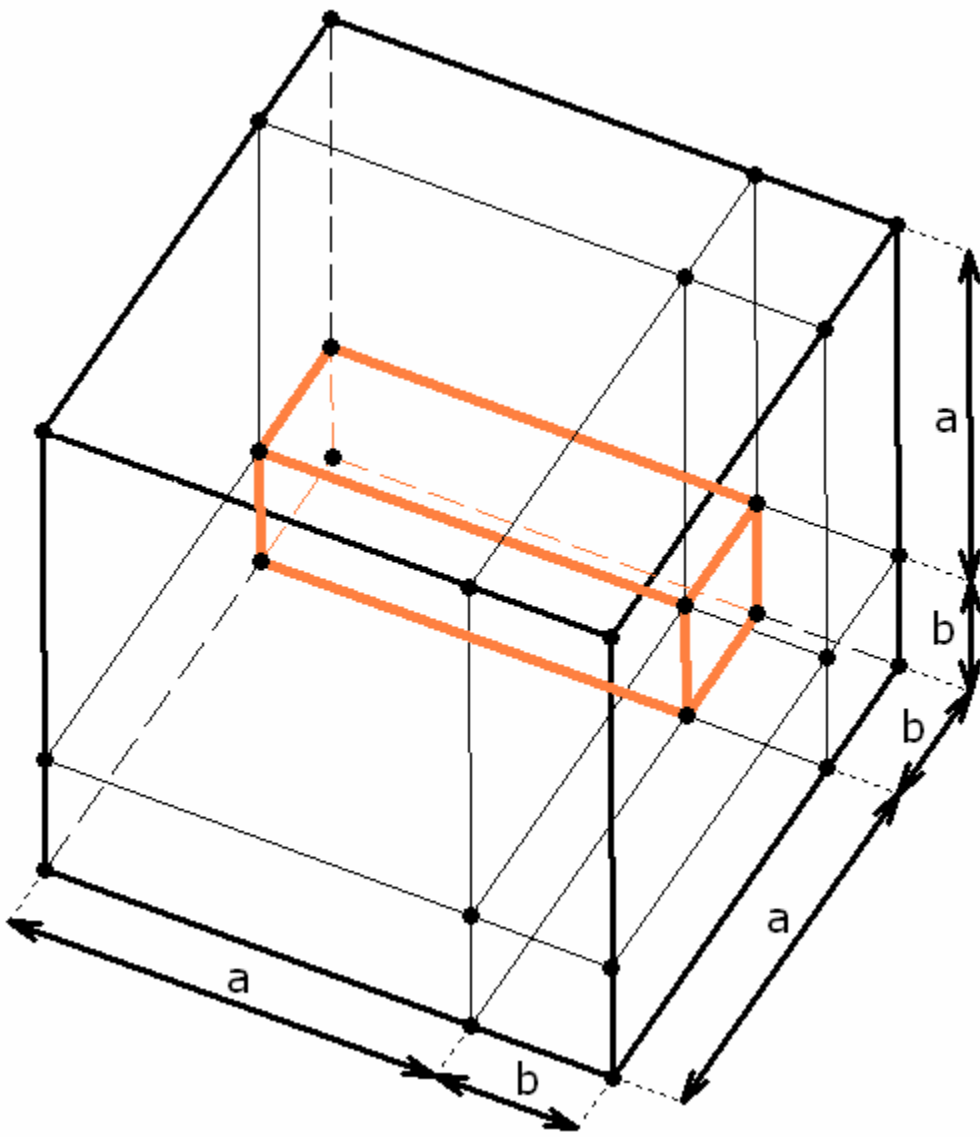

$$+ a^2 b$$

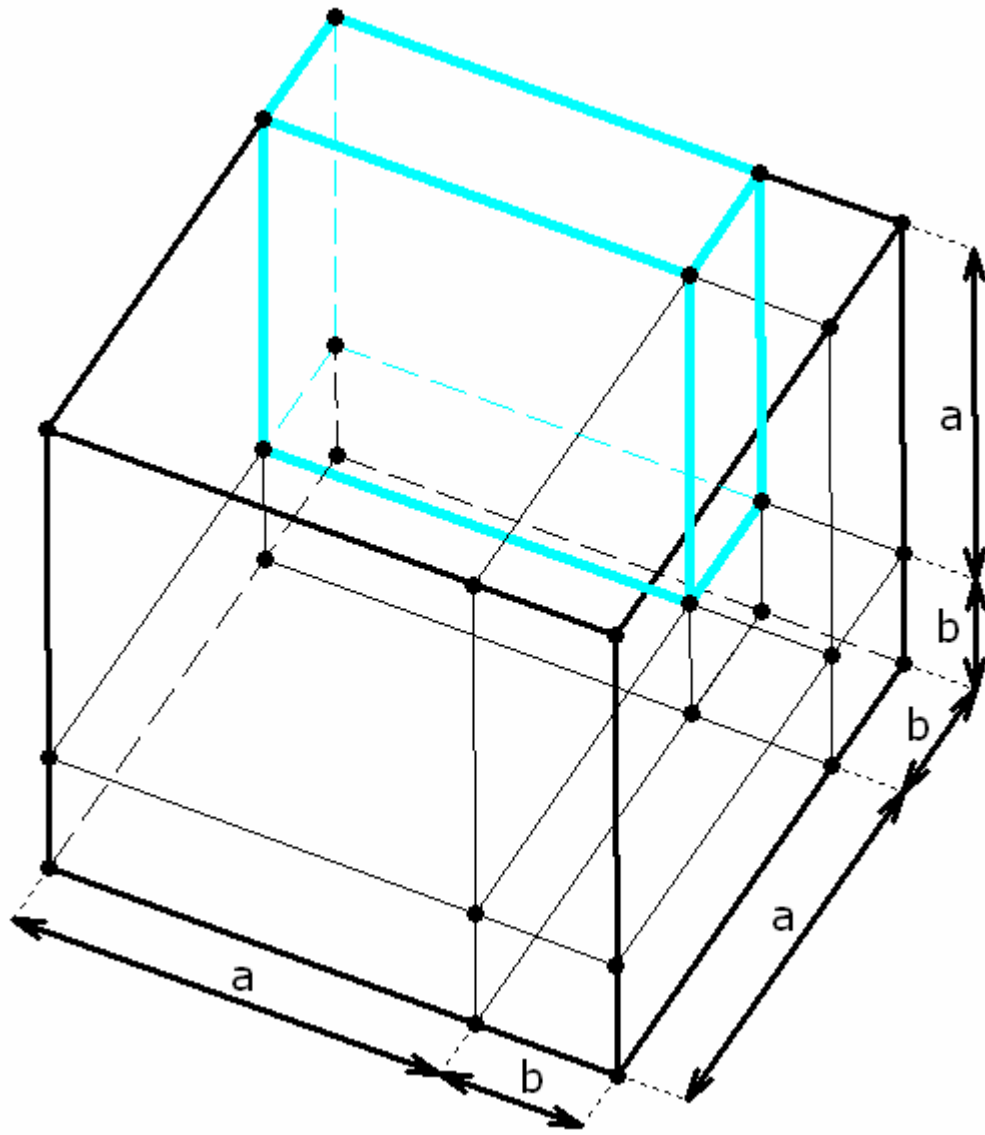

$$+ a^2 b$$

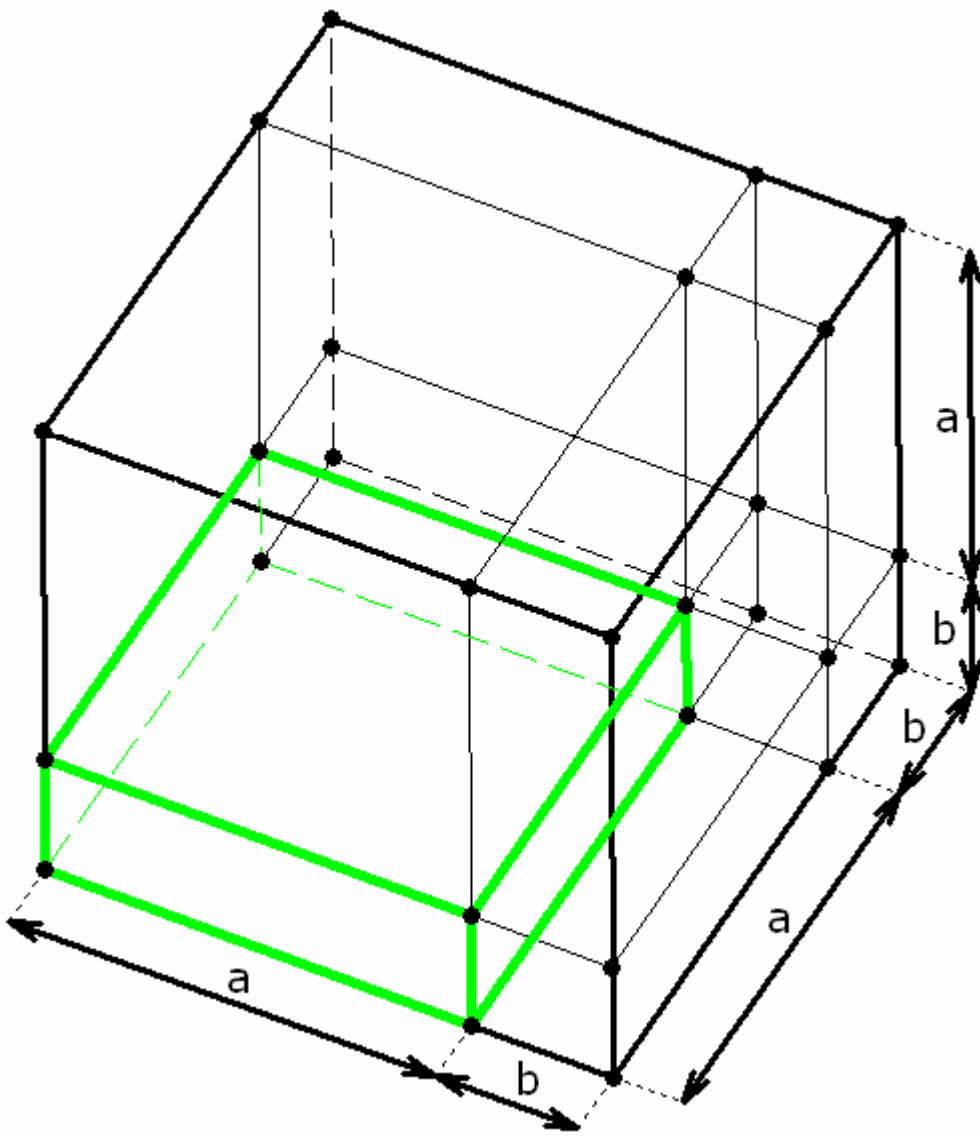

$$+ a^2 b$$

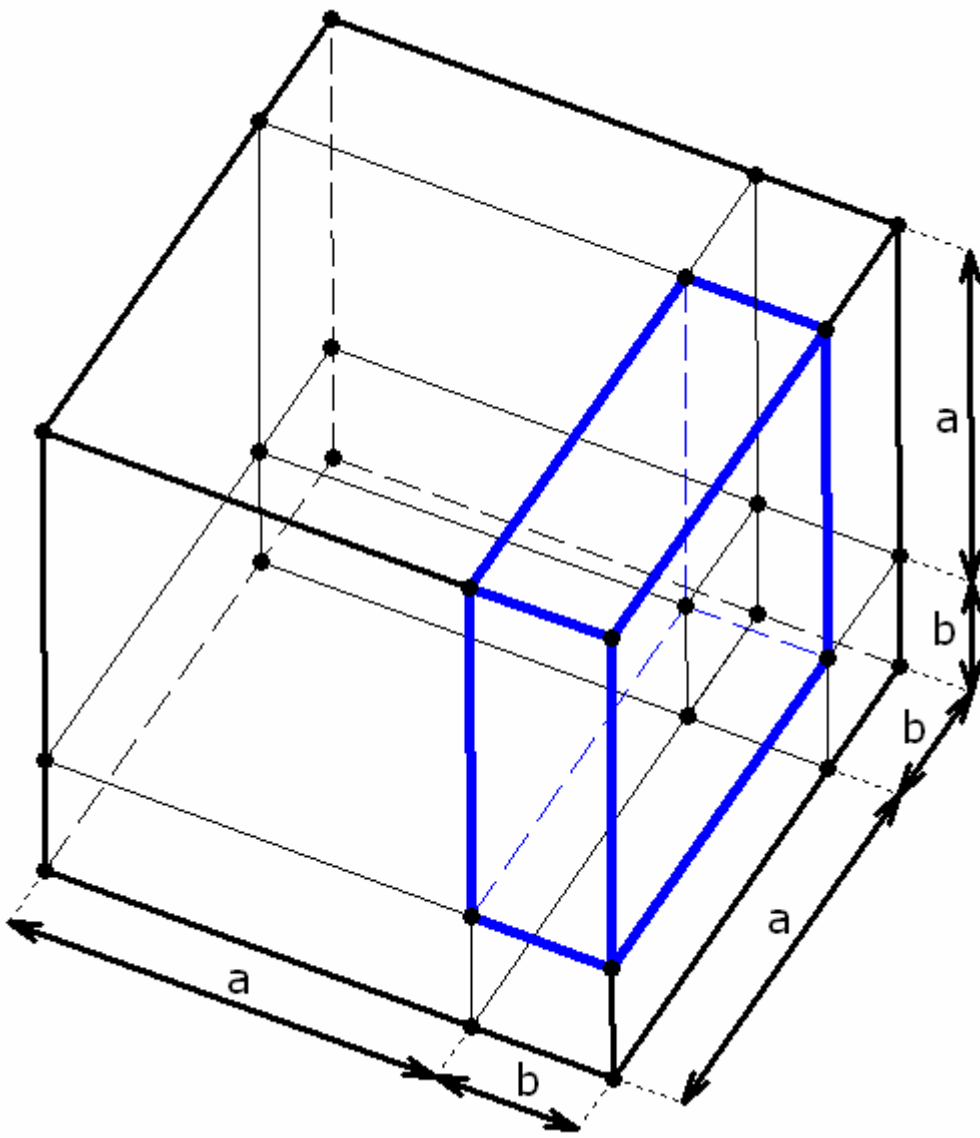

$$+ a^3$$

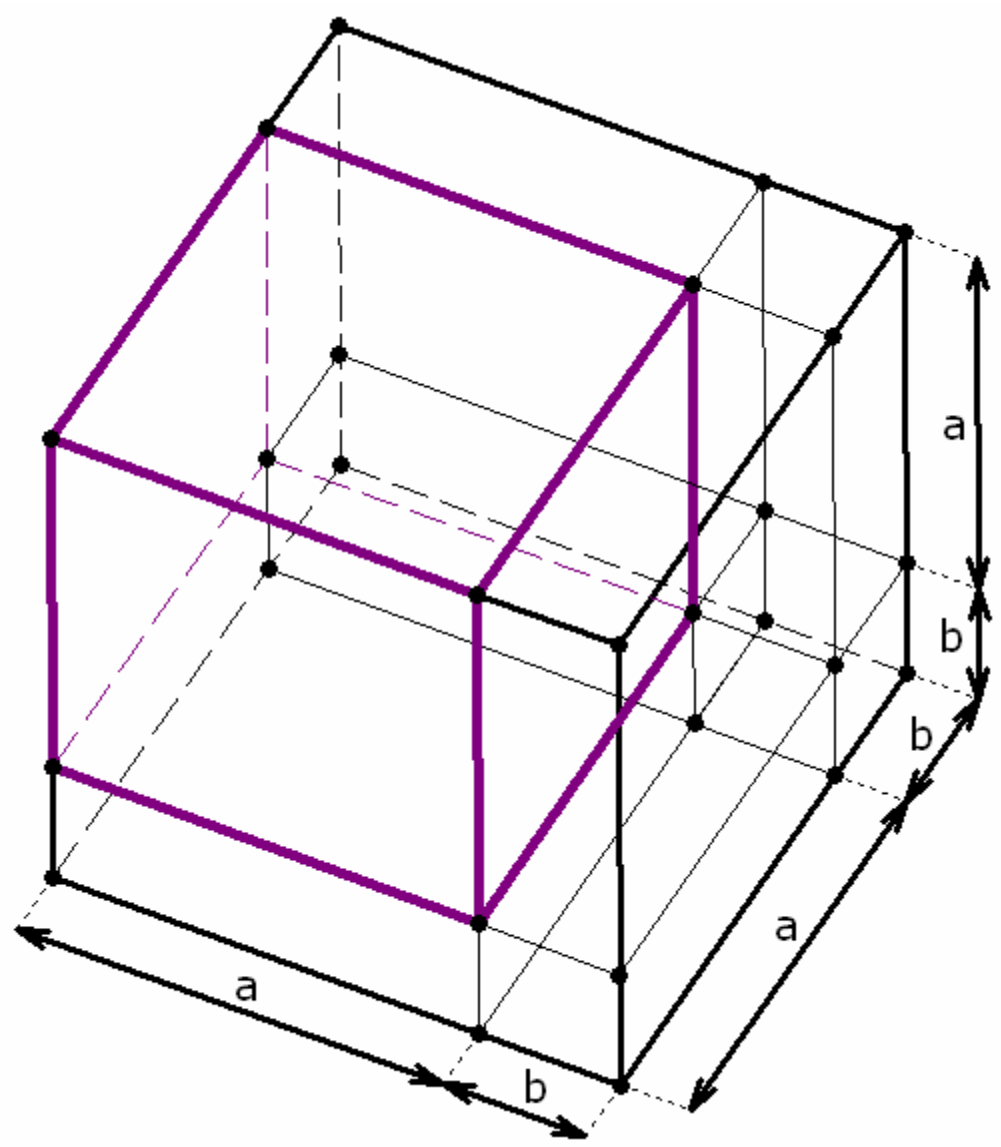

b^3

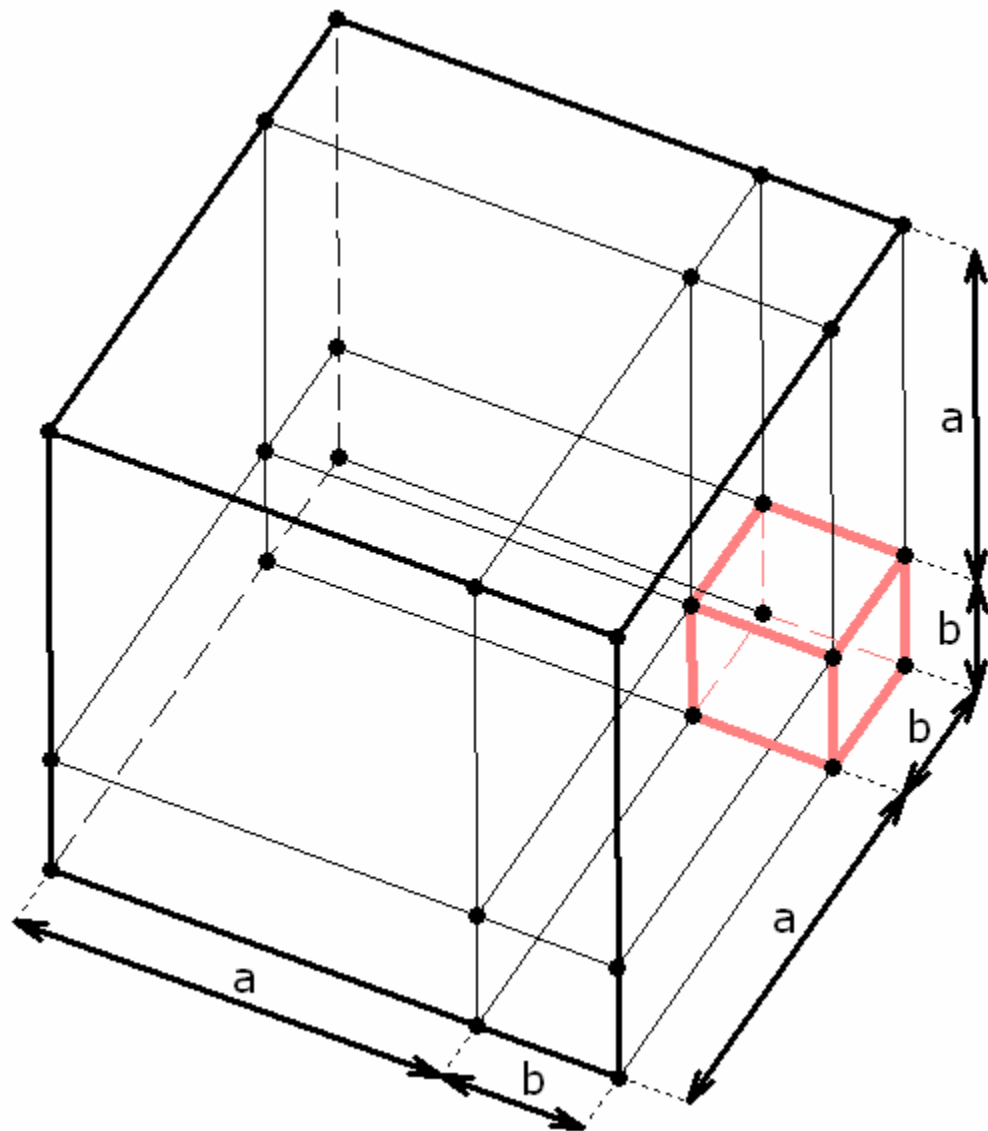

$$+ ab^2$$

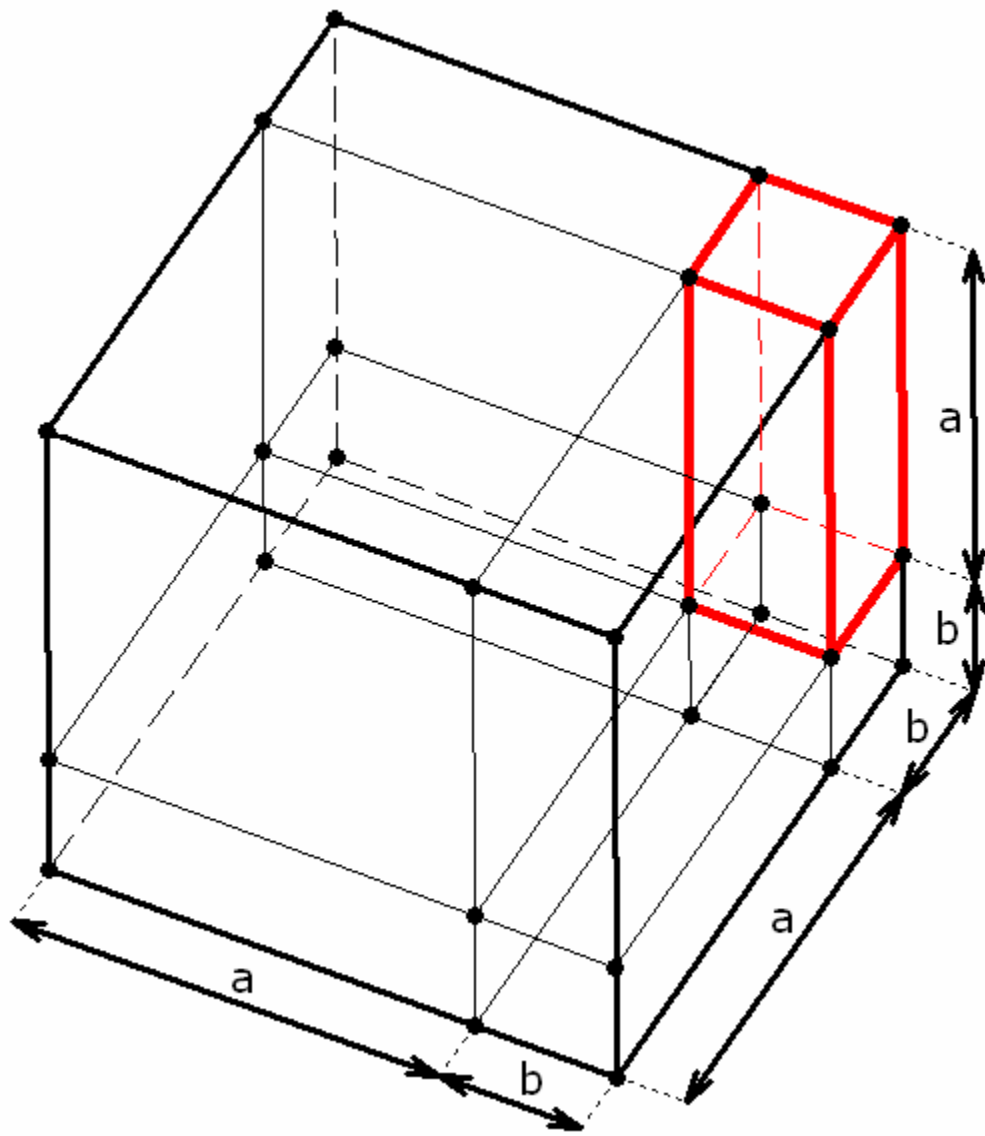

$$+ ab^2$$

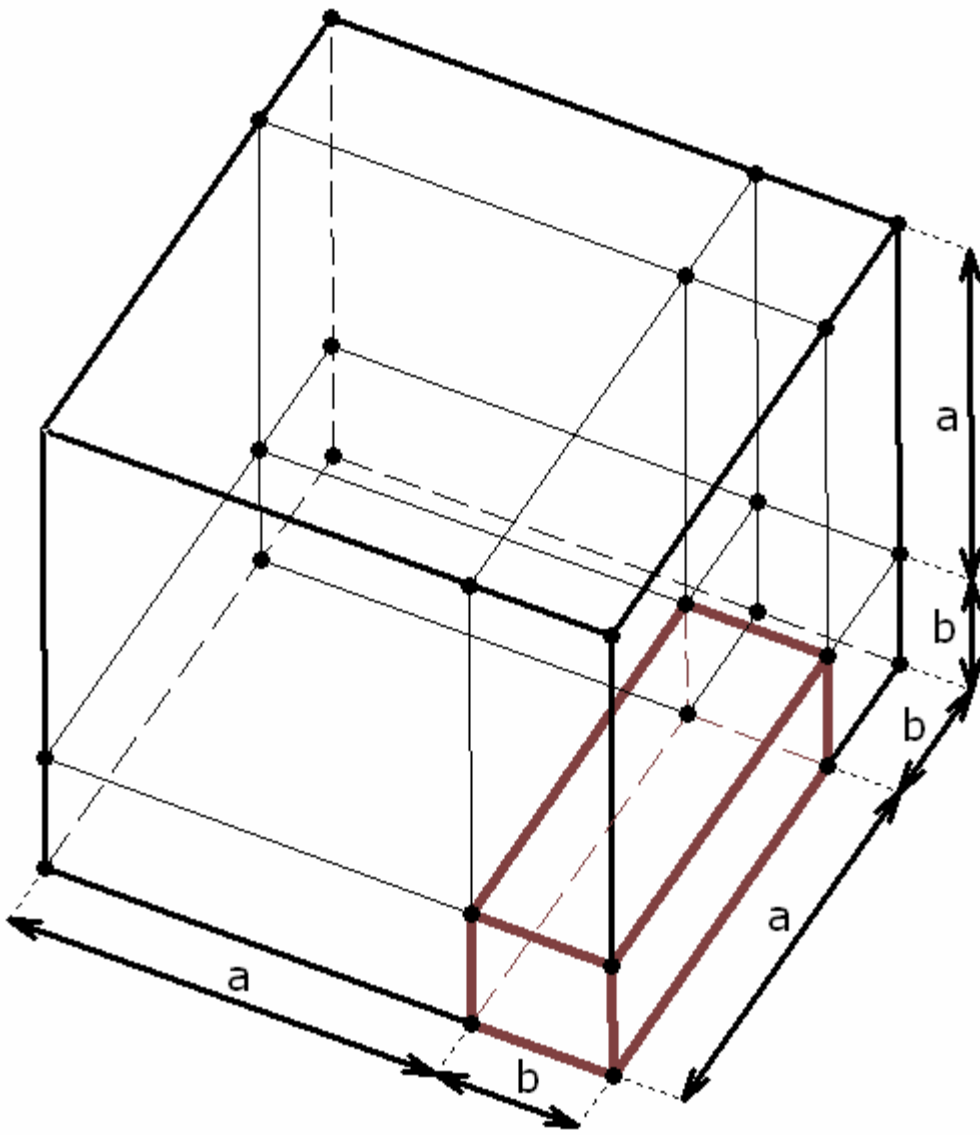

$$+ ab^2$$

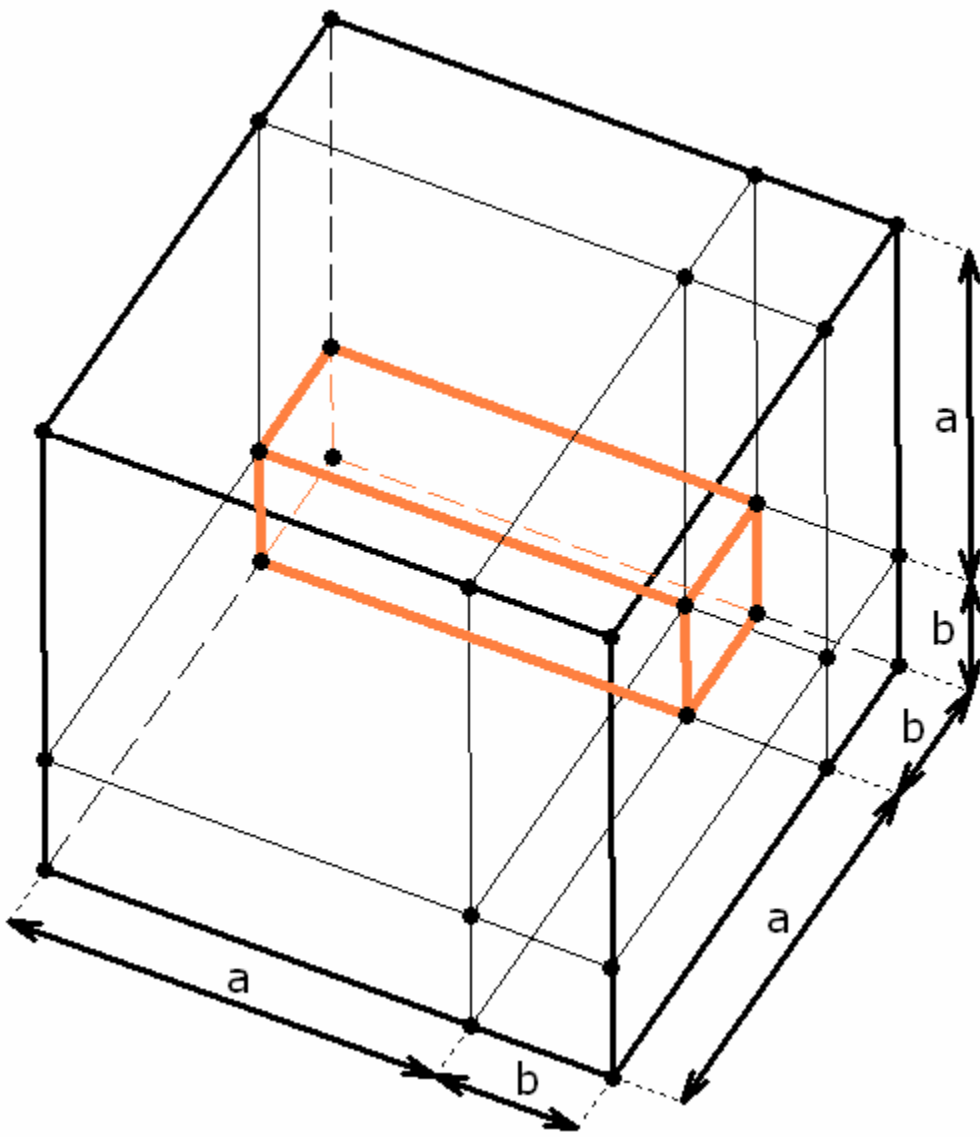

$$+ a^2 b$$

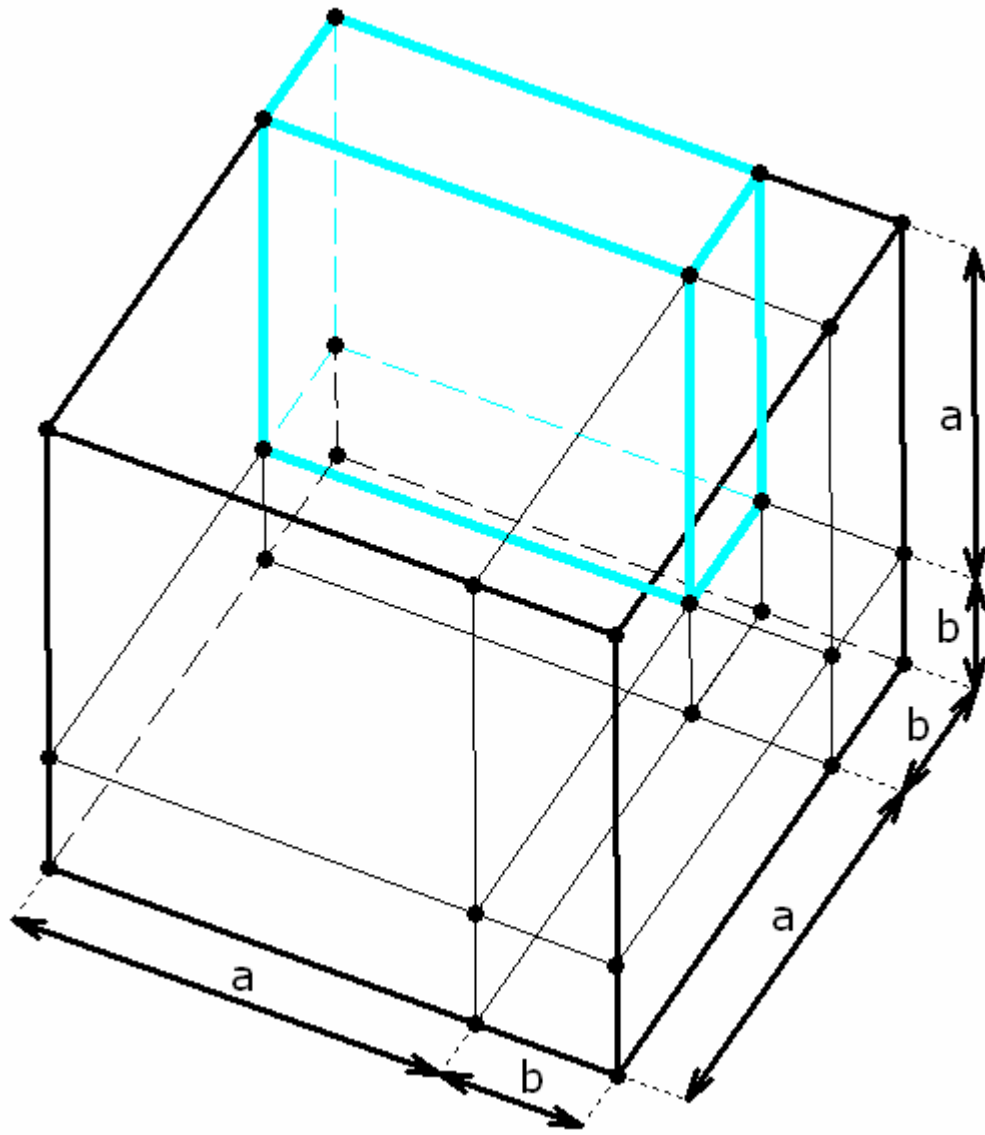

$$+ a^2 b$$

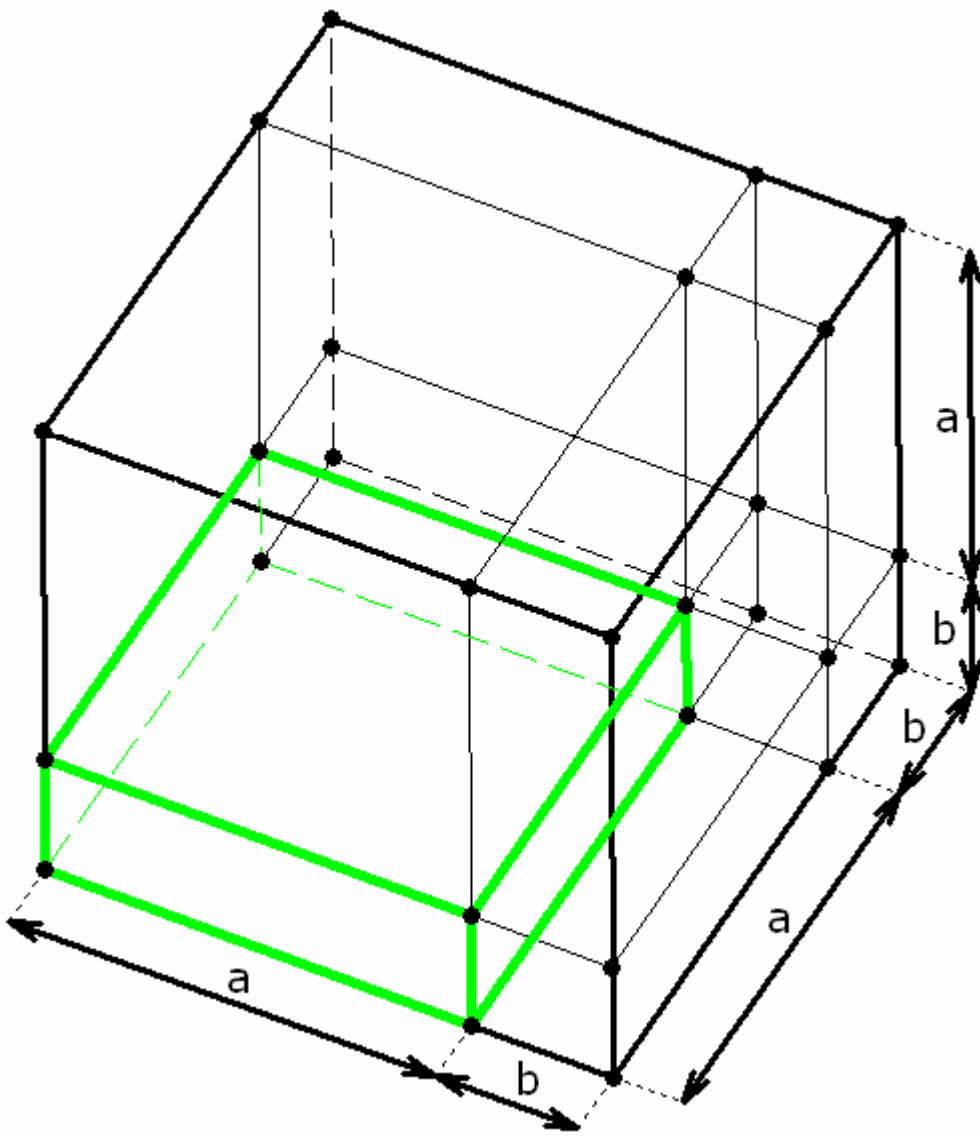

$$+ a^2 b$$

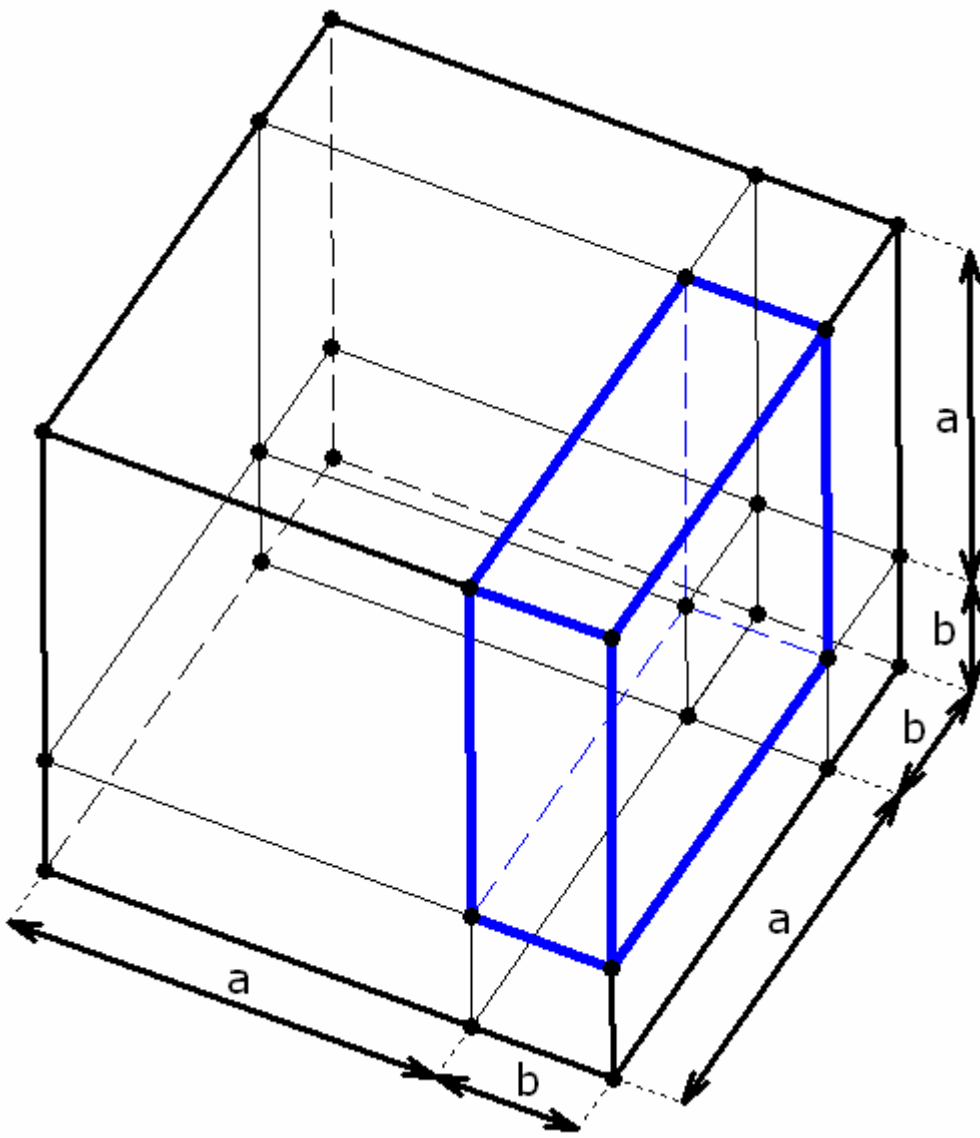

$$+ a^3$$

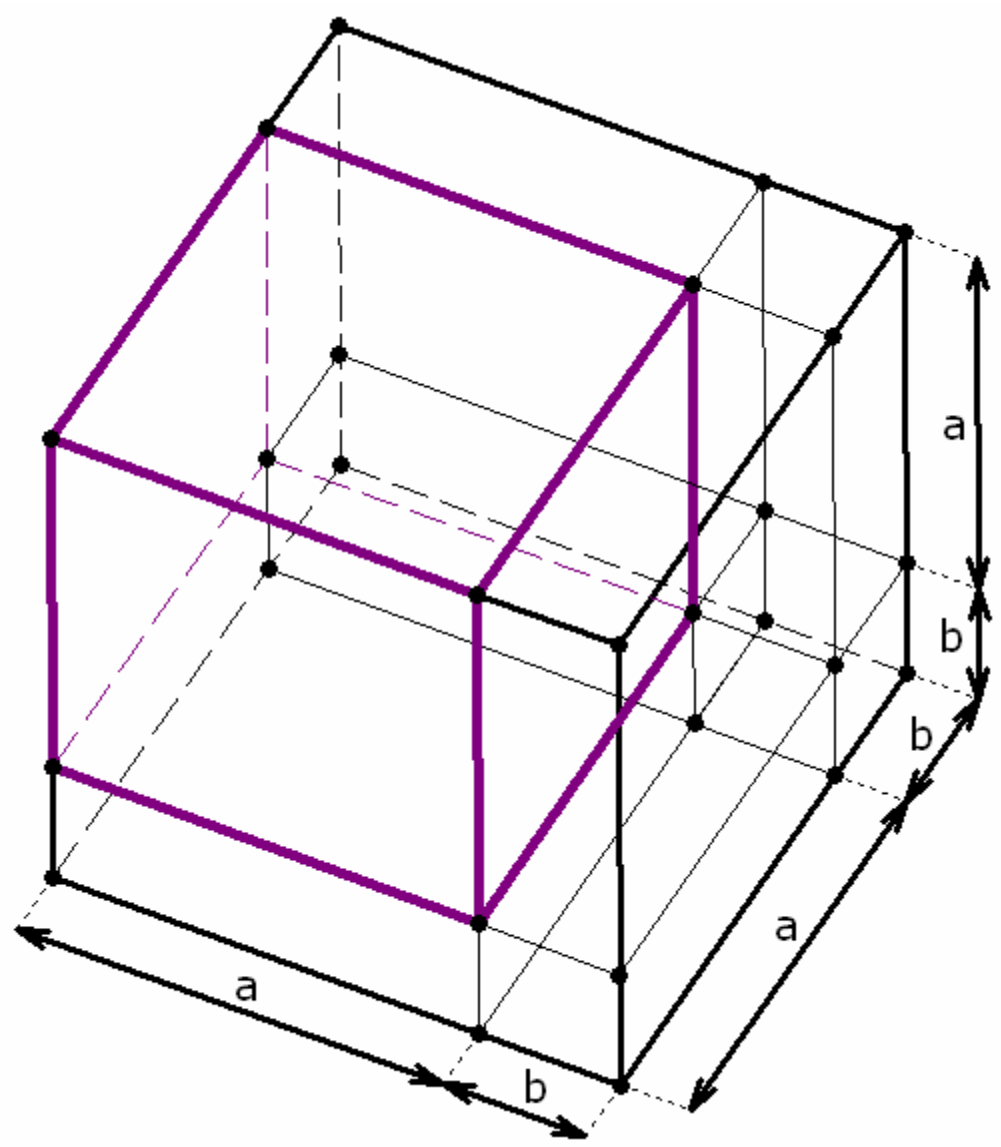

b^3

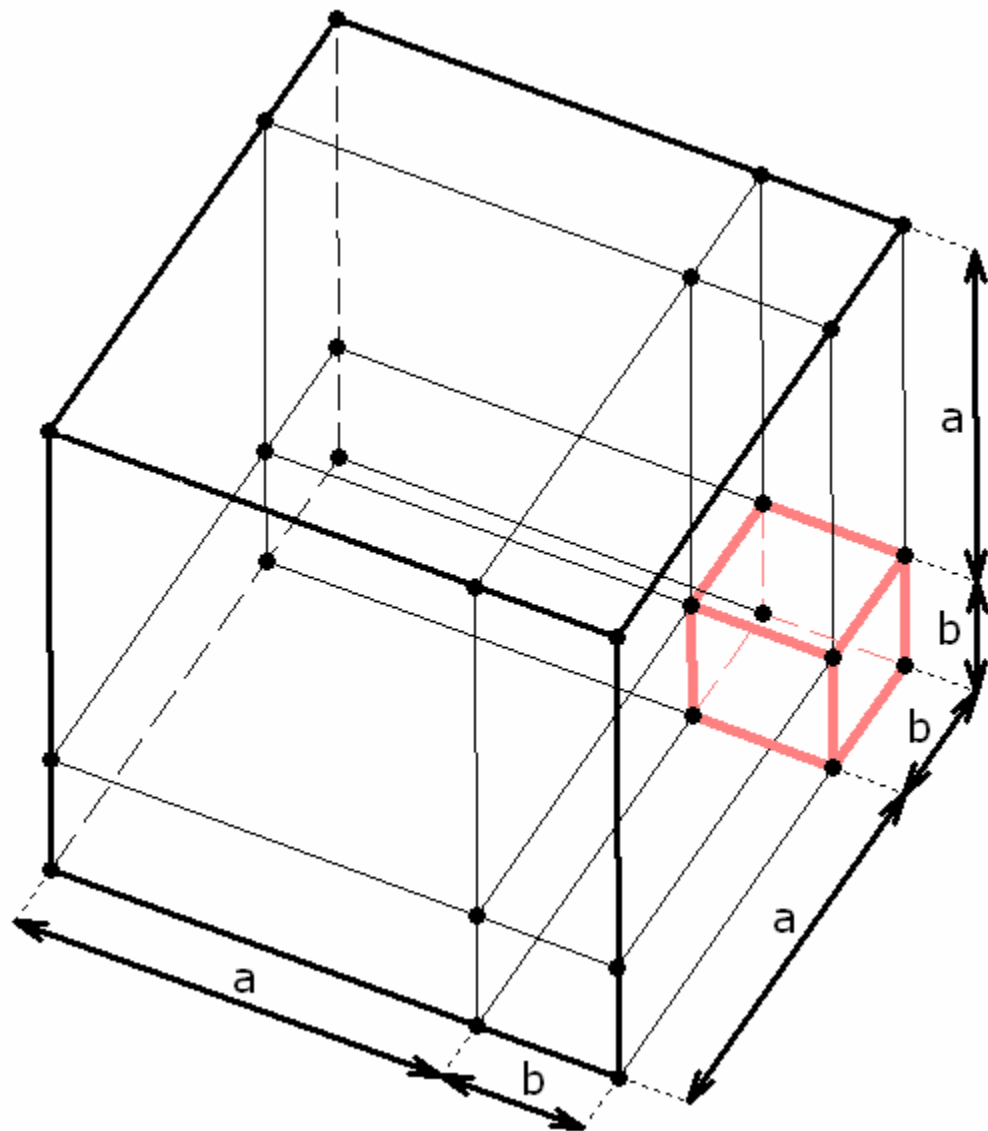

$$+ ab^2$$

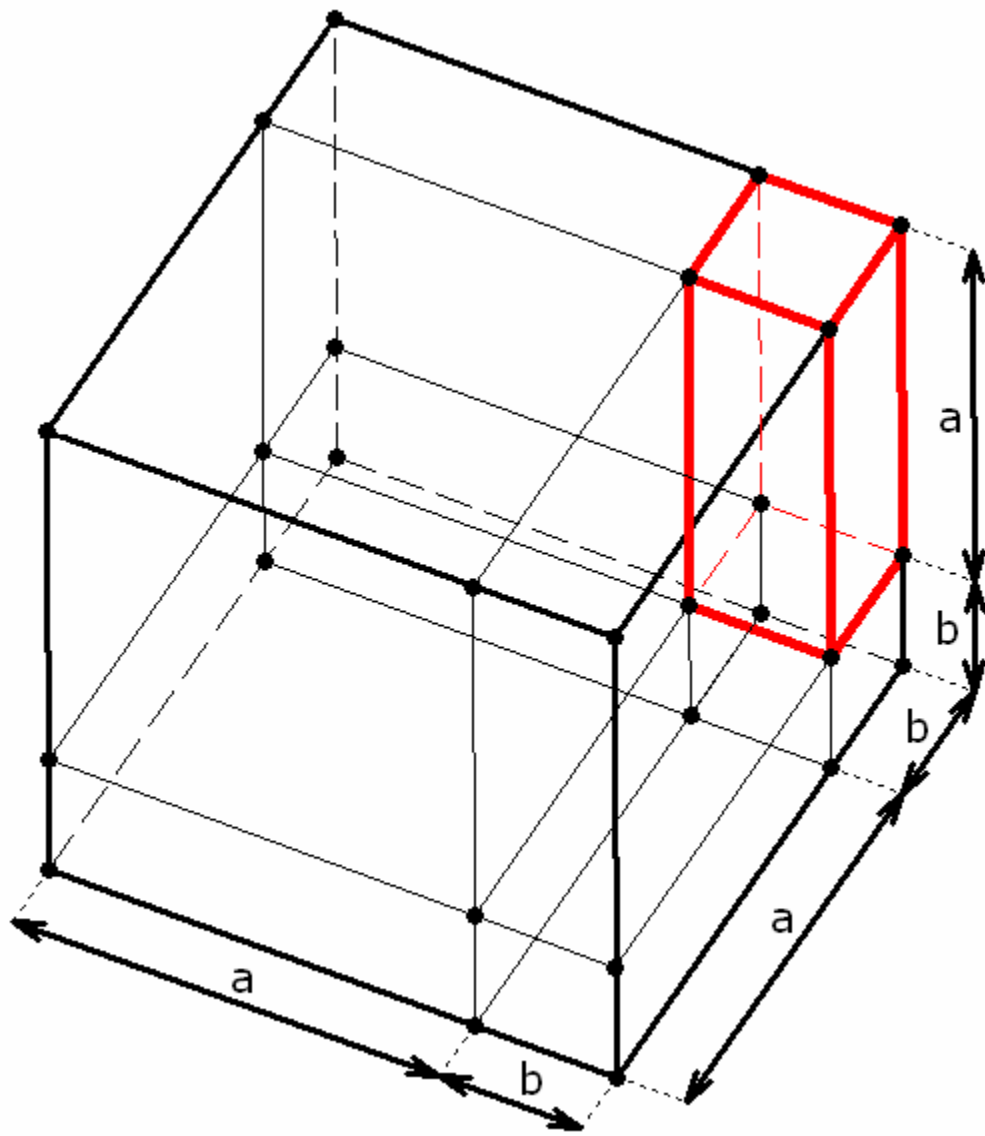

$$+ ab^2$$

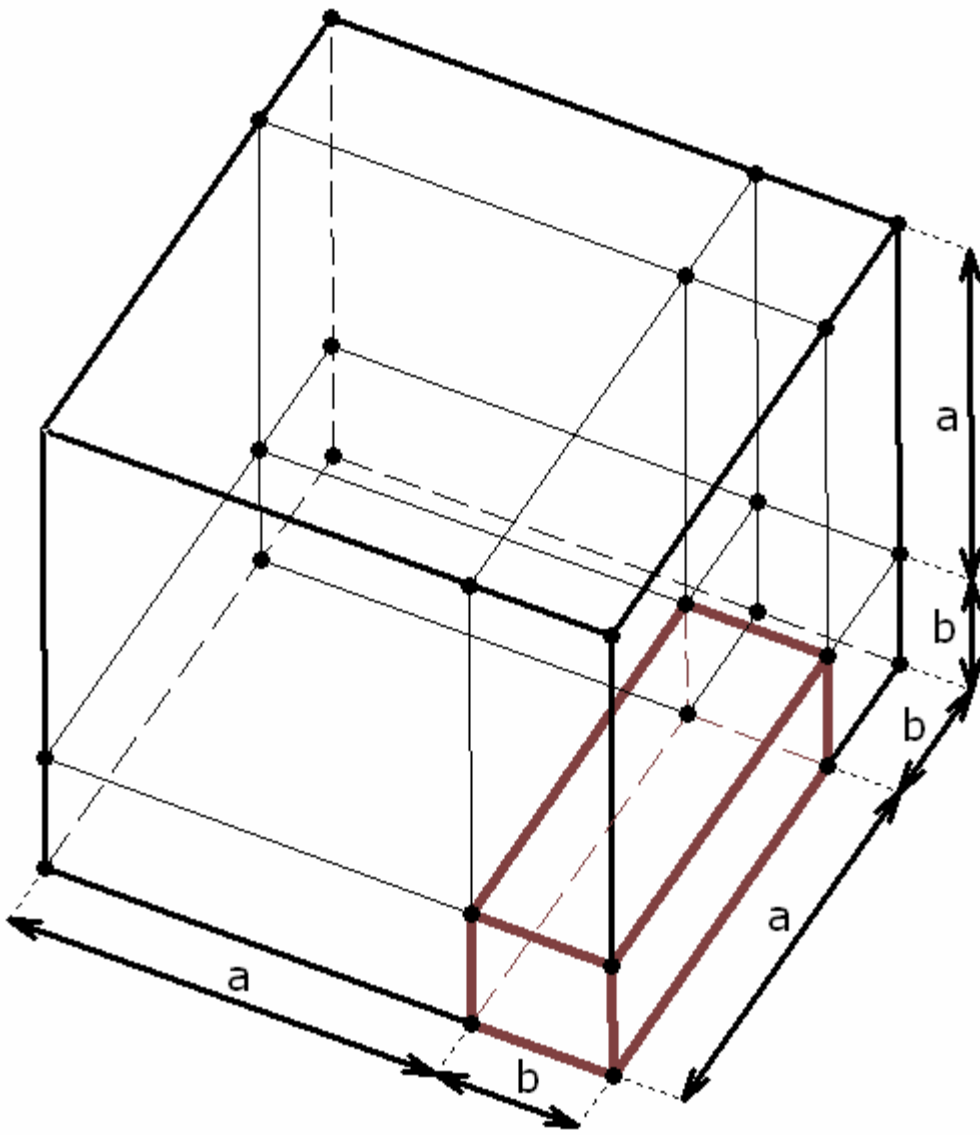

$$+ ab^2$$

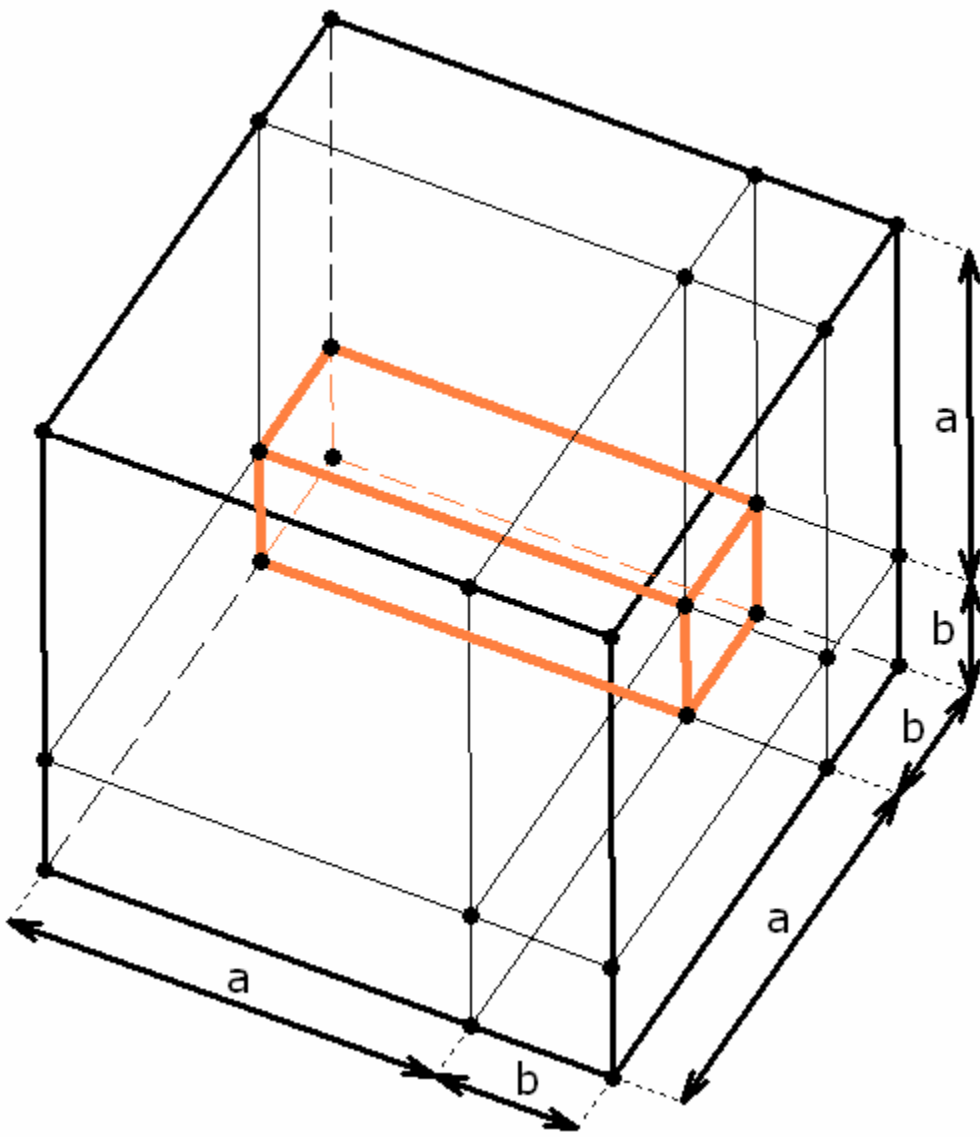

$$+ a^2 b$$

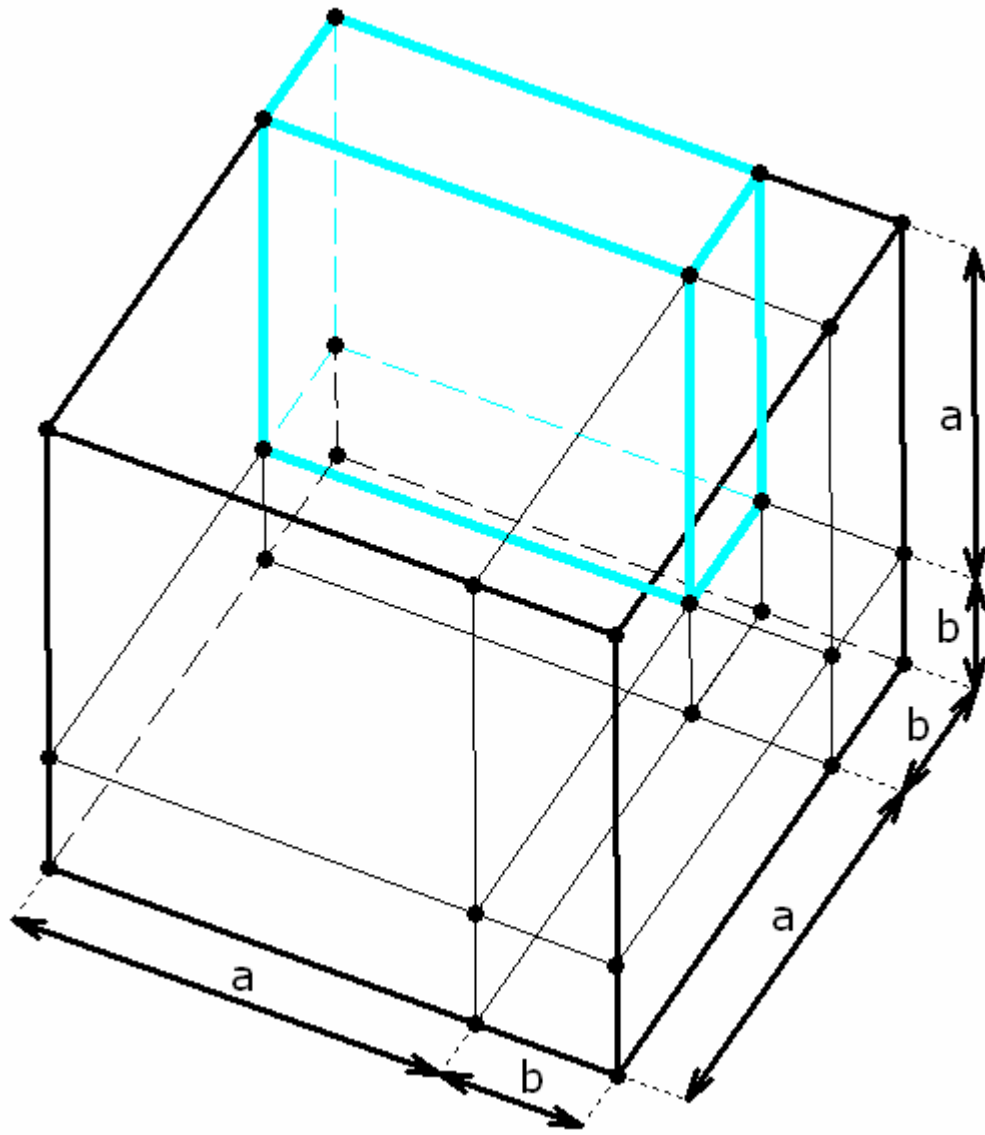

$$+ a^2 b$$

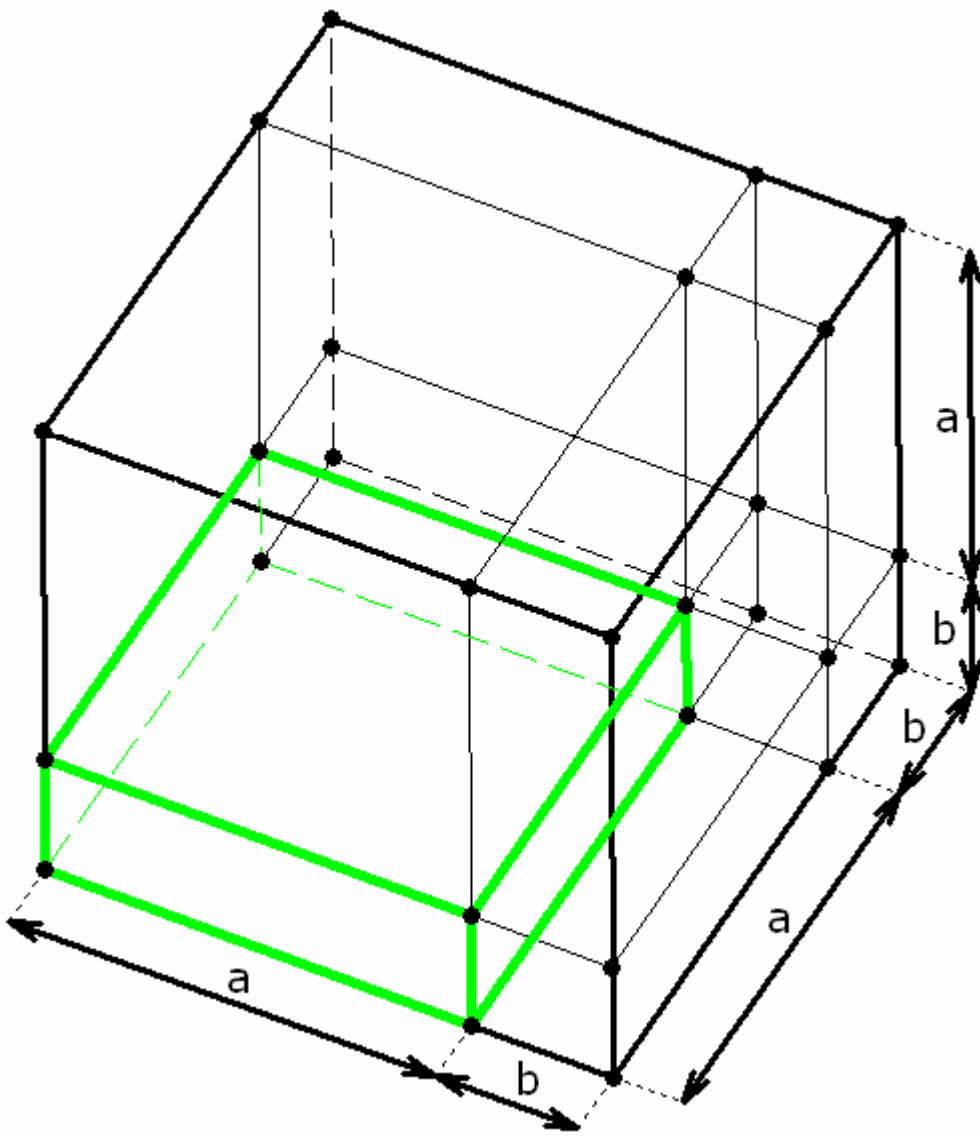

$$+ a^2 b$$

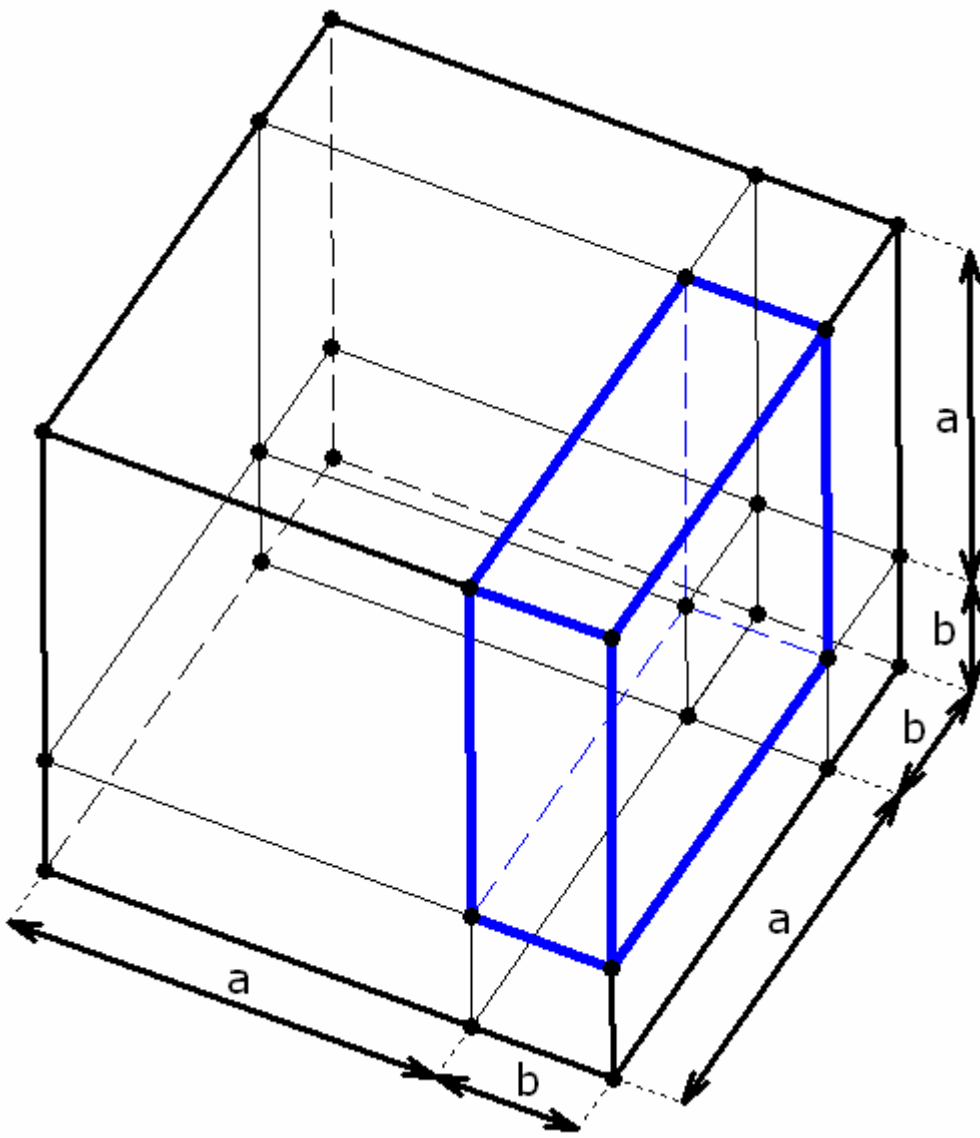

$$+ a^3$$

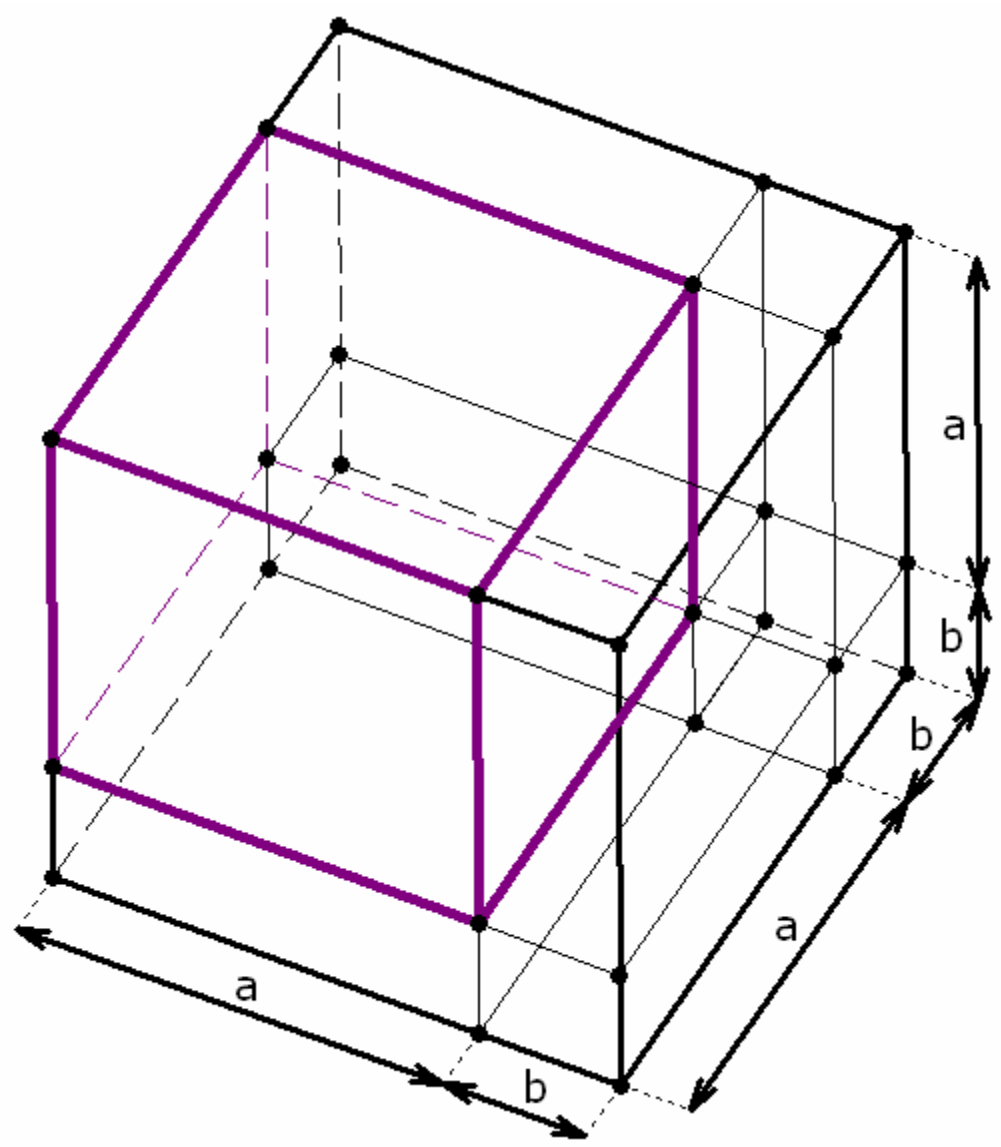

b^3

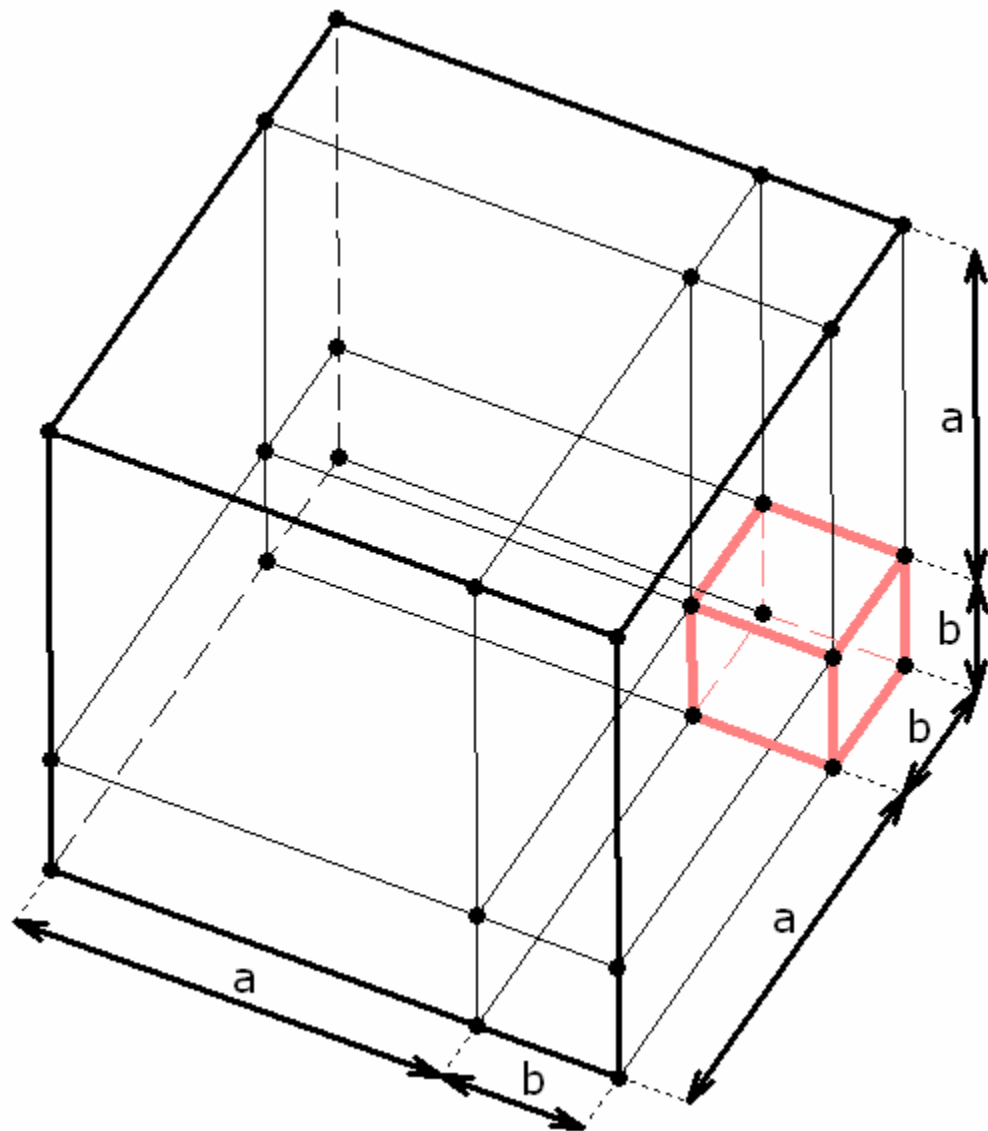

$$+ ab^2$$

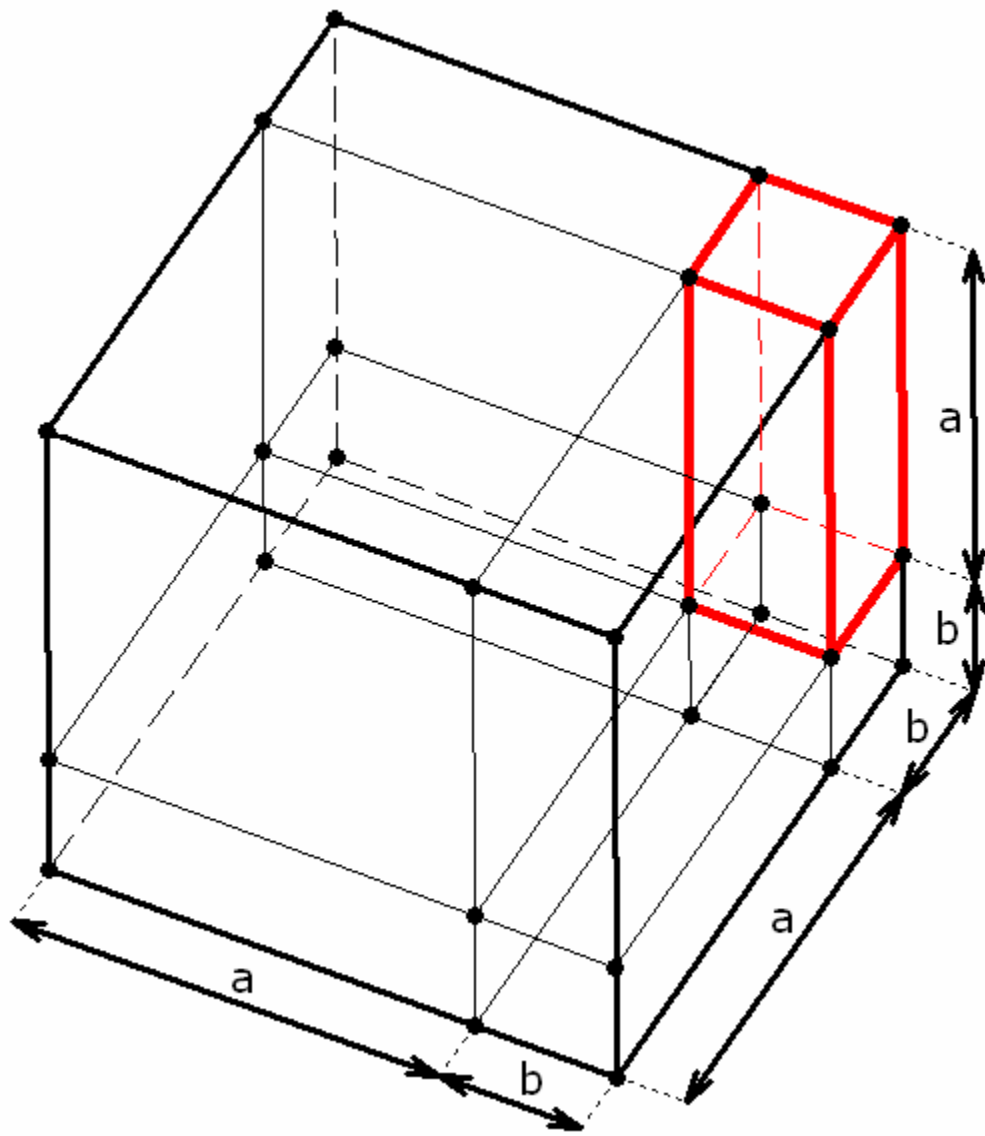

$$+ ab^2$$

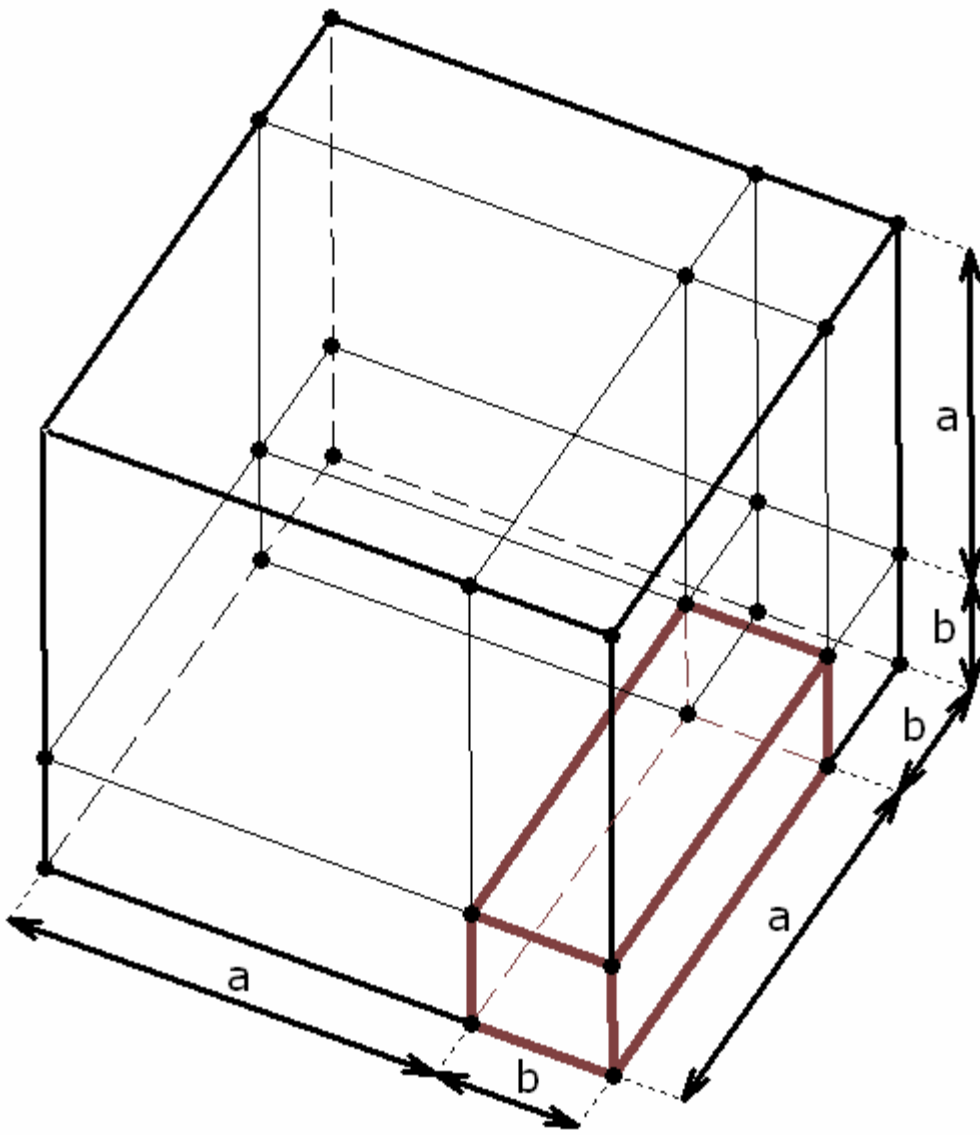

$$+ ab^2$$

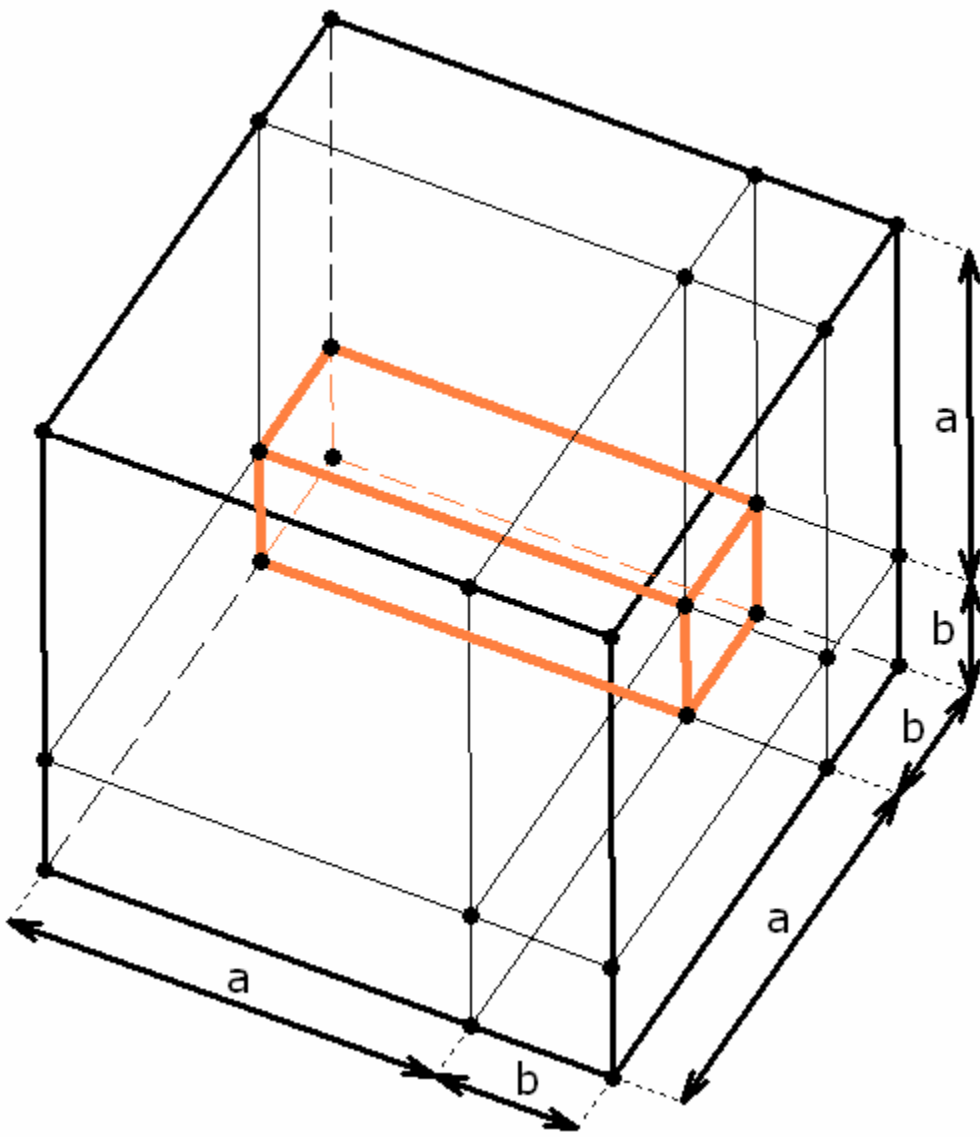

$$+ a^2 b$$

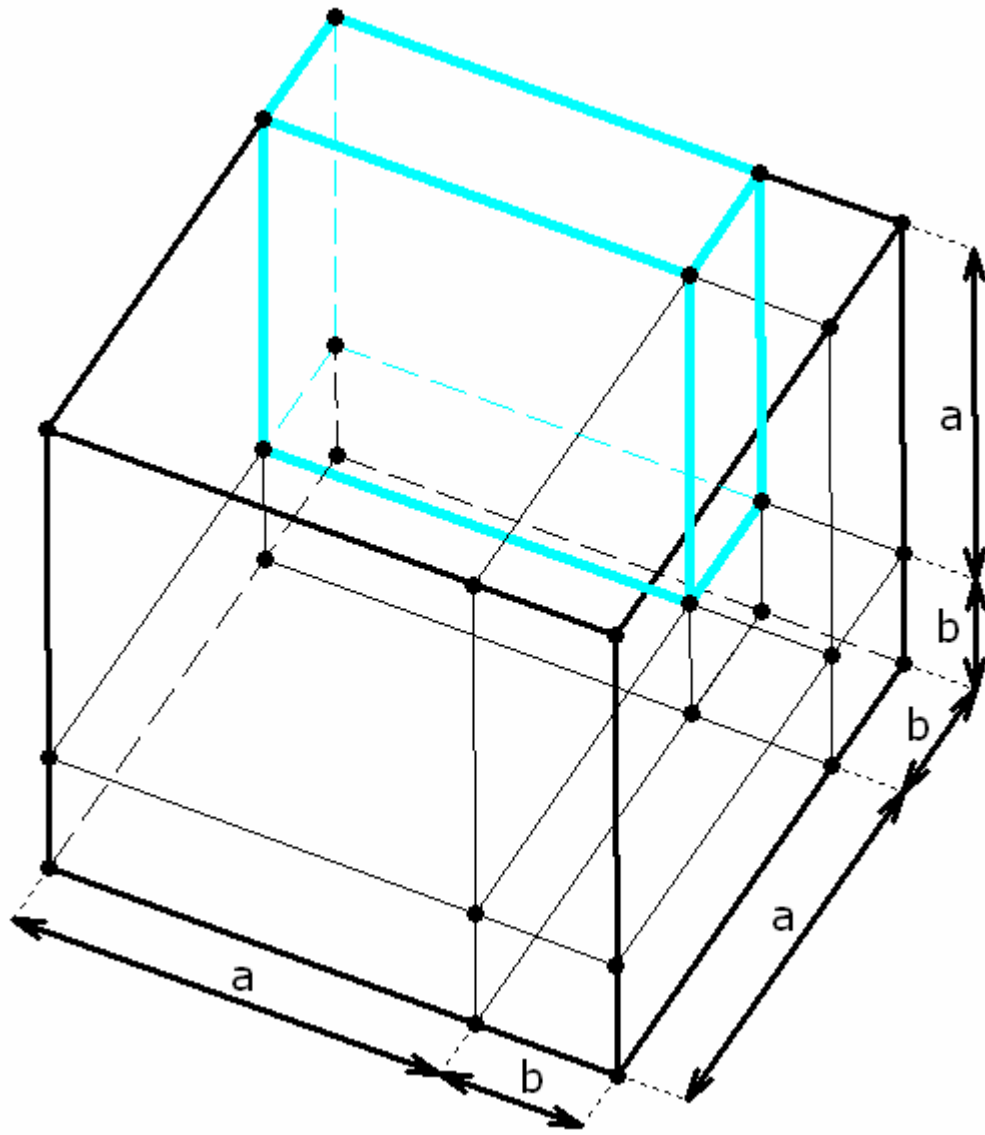

$+ a^2 b$

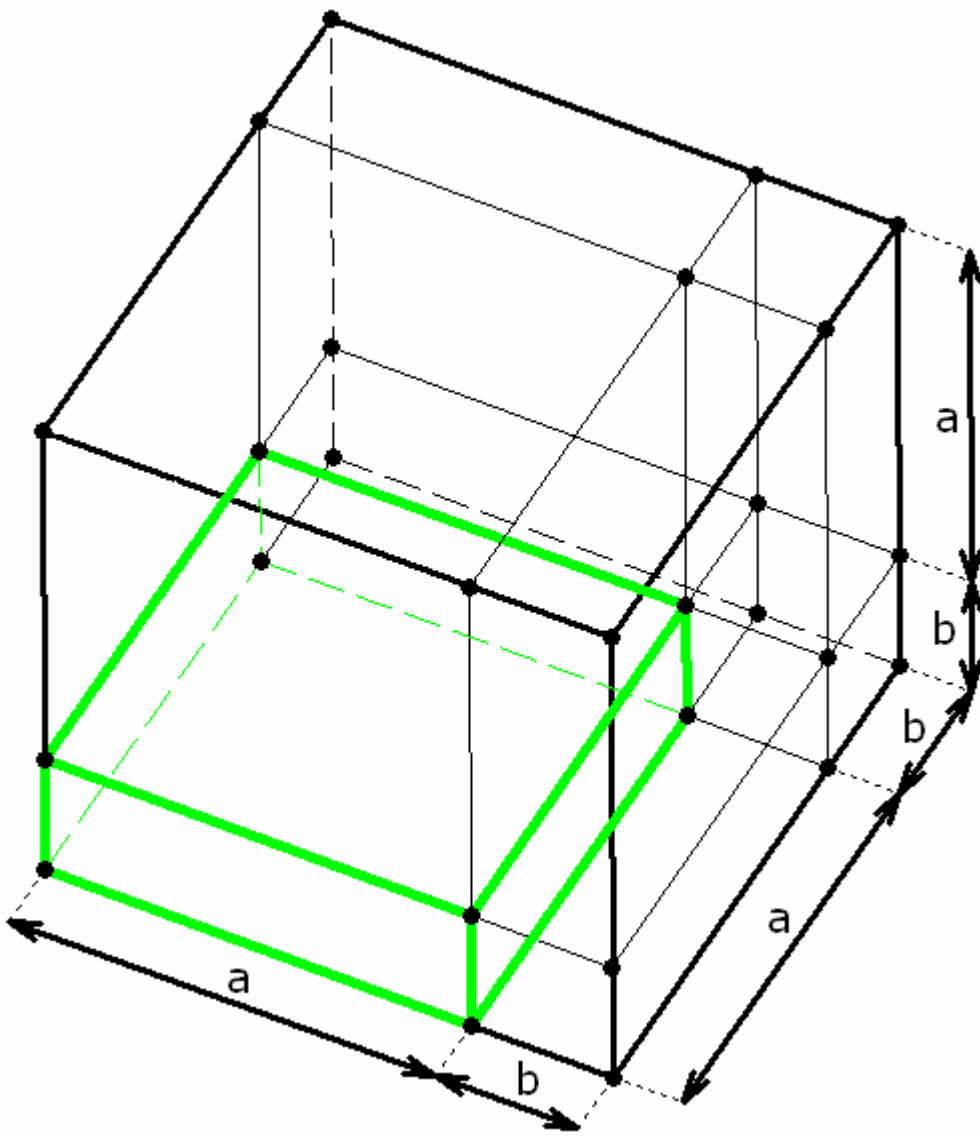

$$+ a^2 b$$

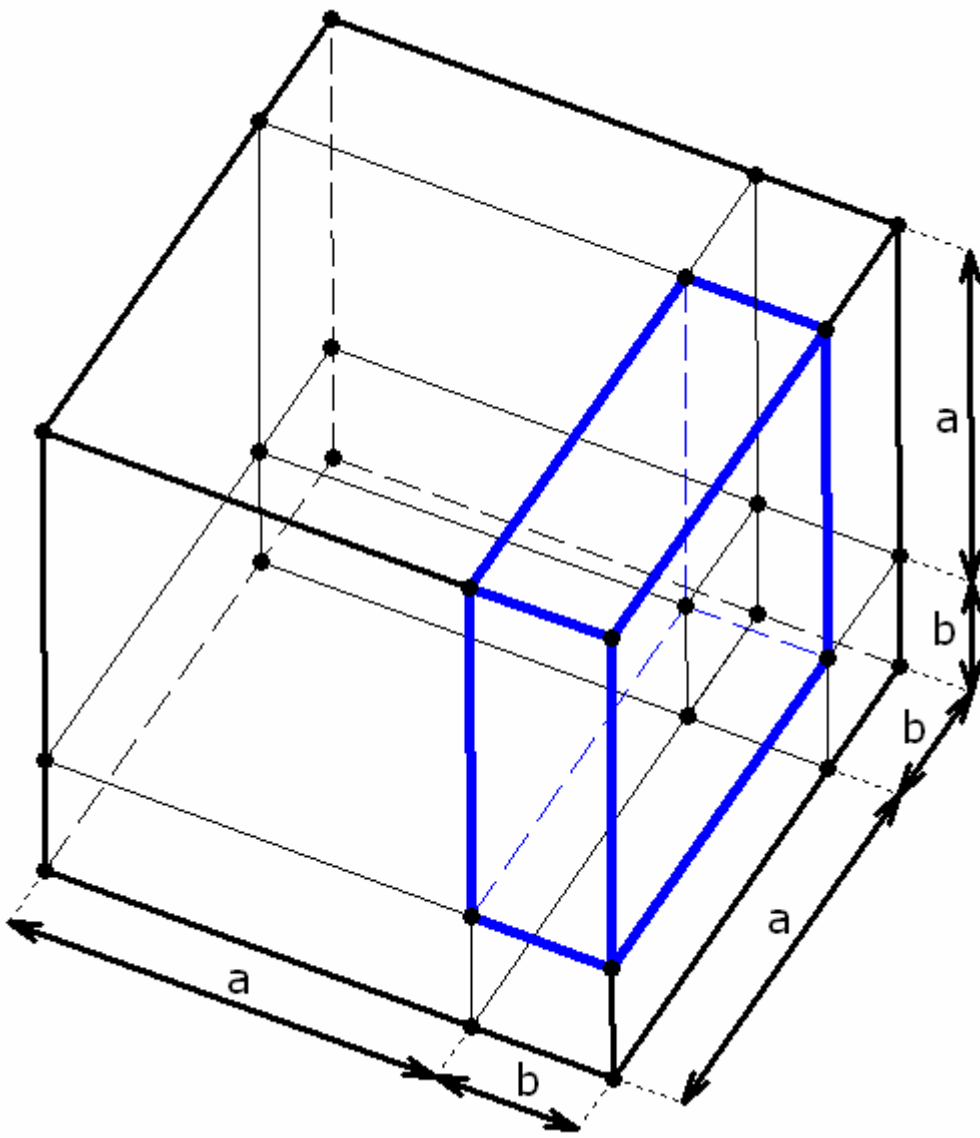

$$+ a^3$$

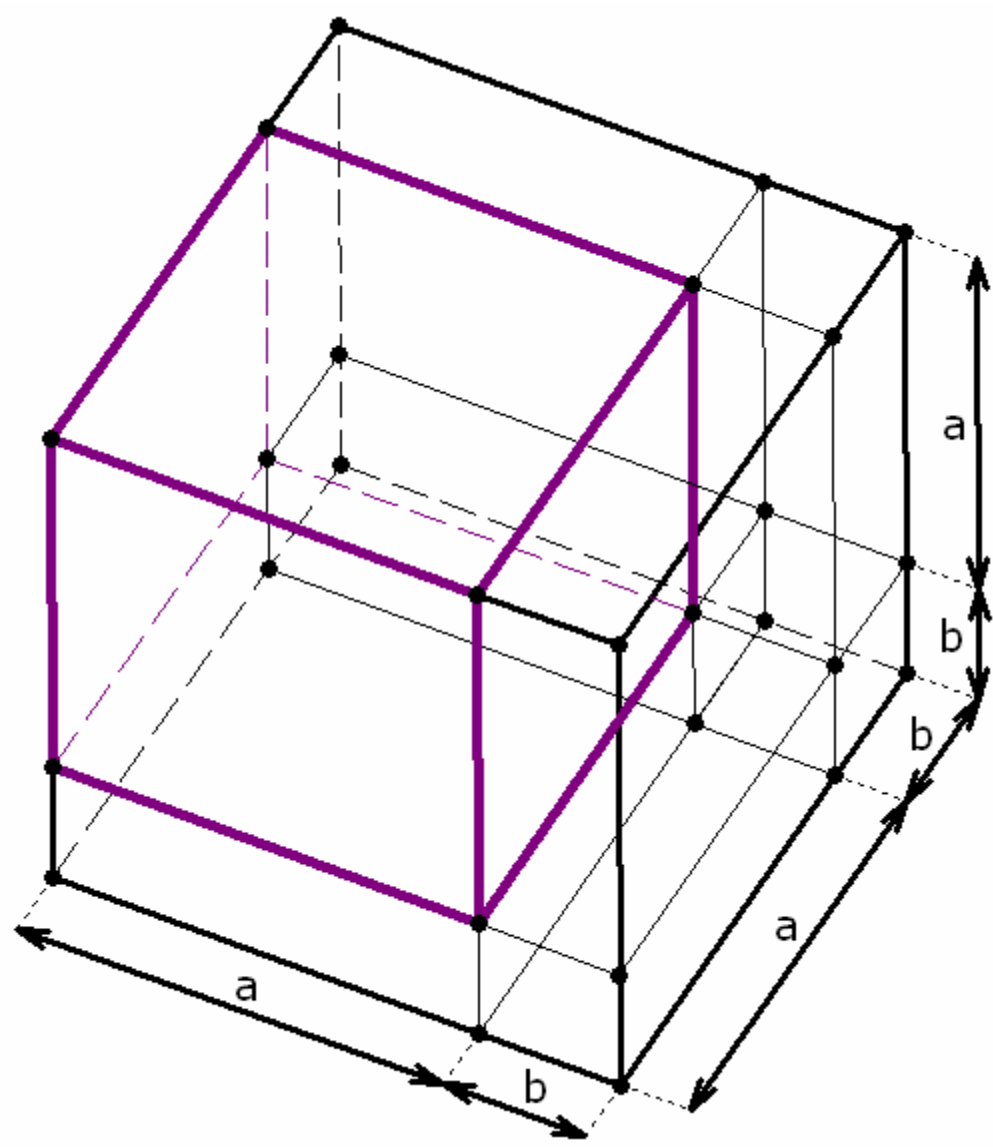

b^3

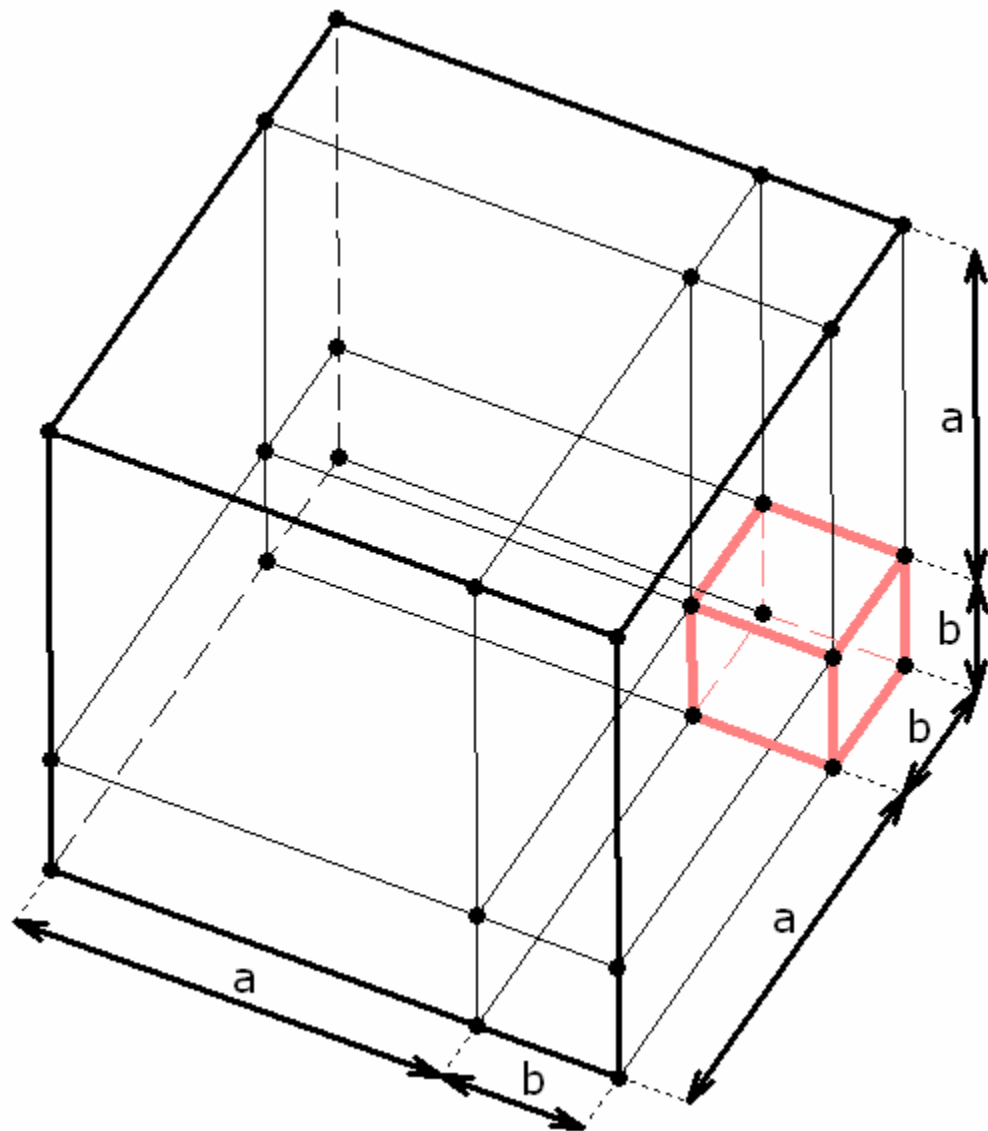

$$+ ab^2$$

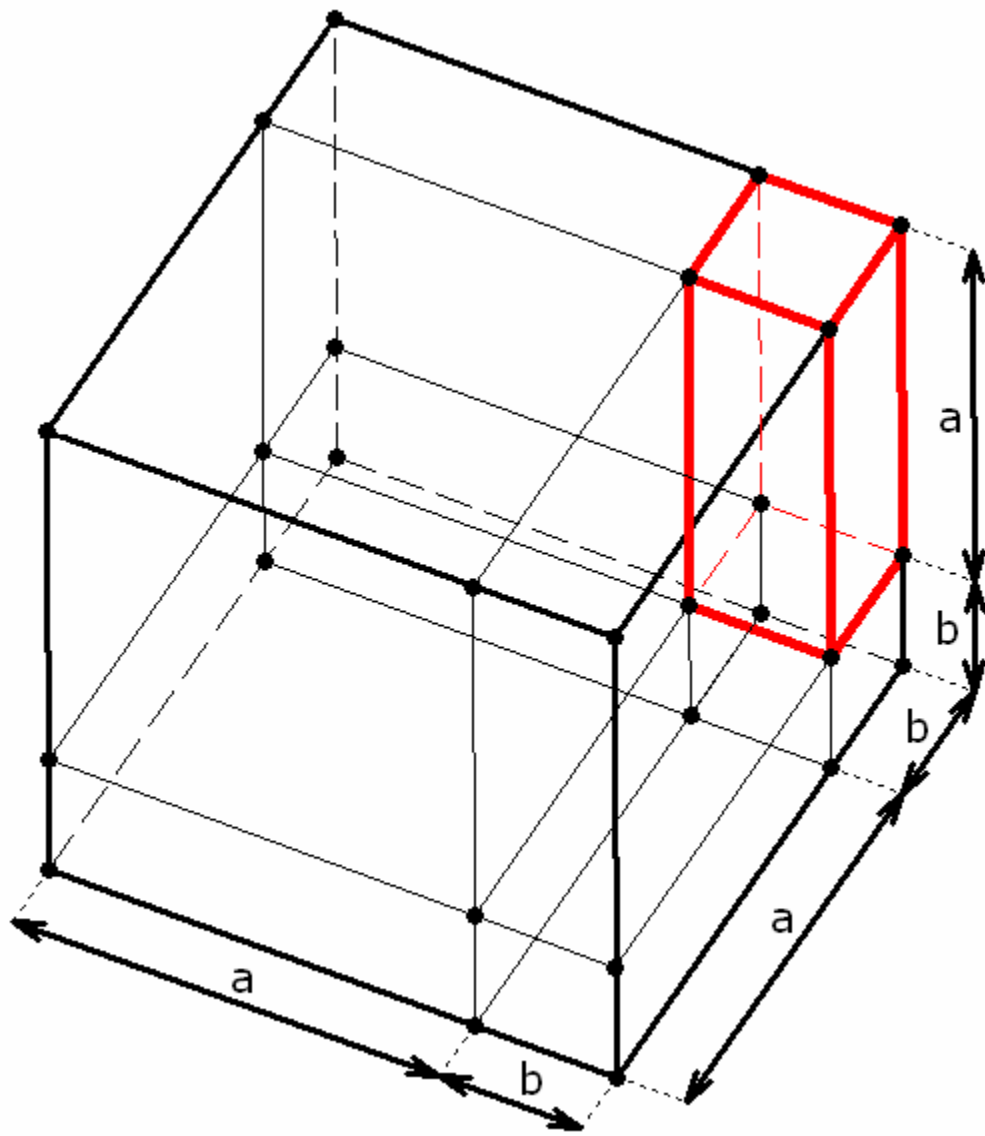

$$+ ab^2$$

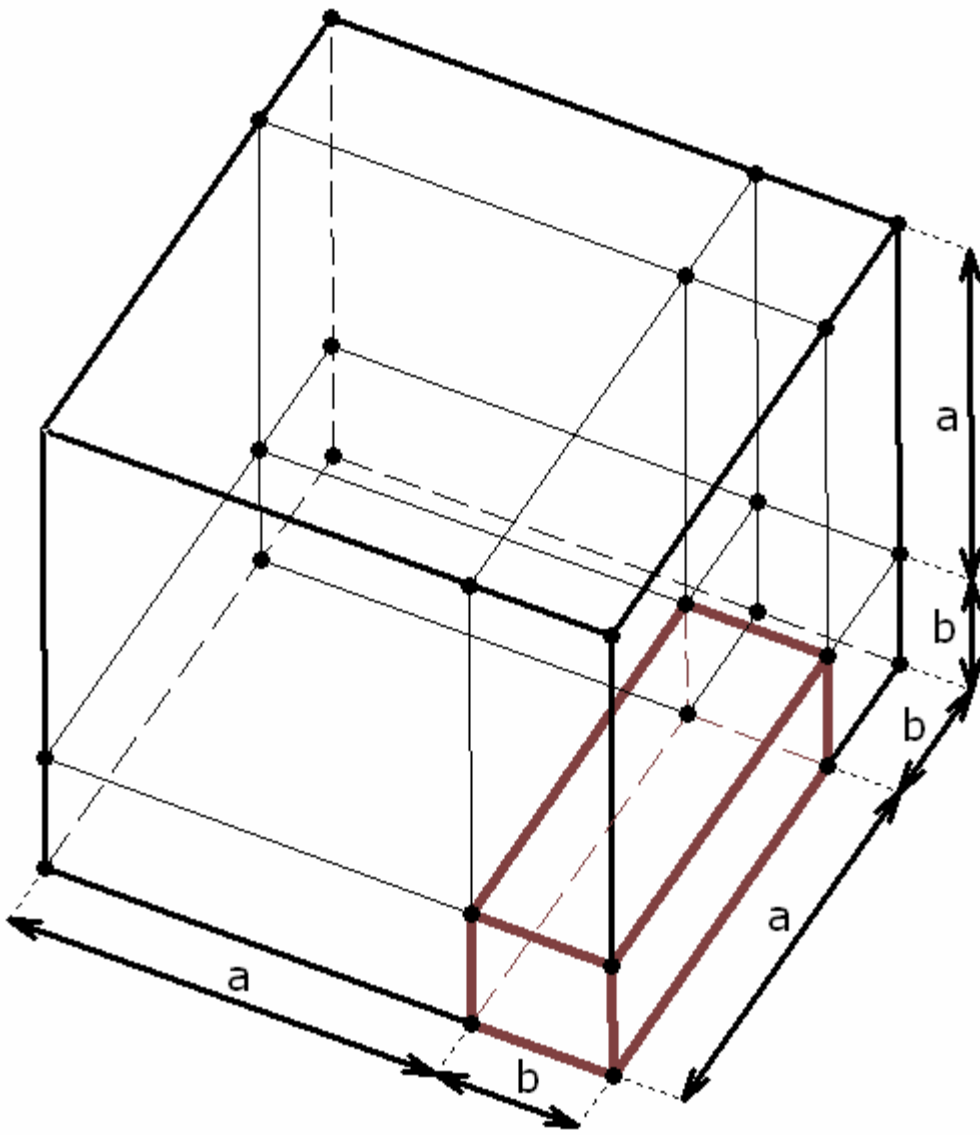

$$+ ab^2$$

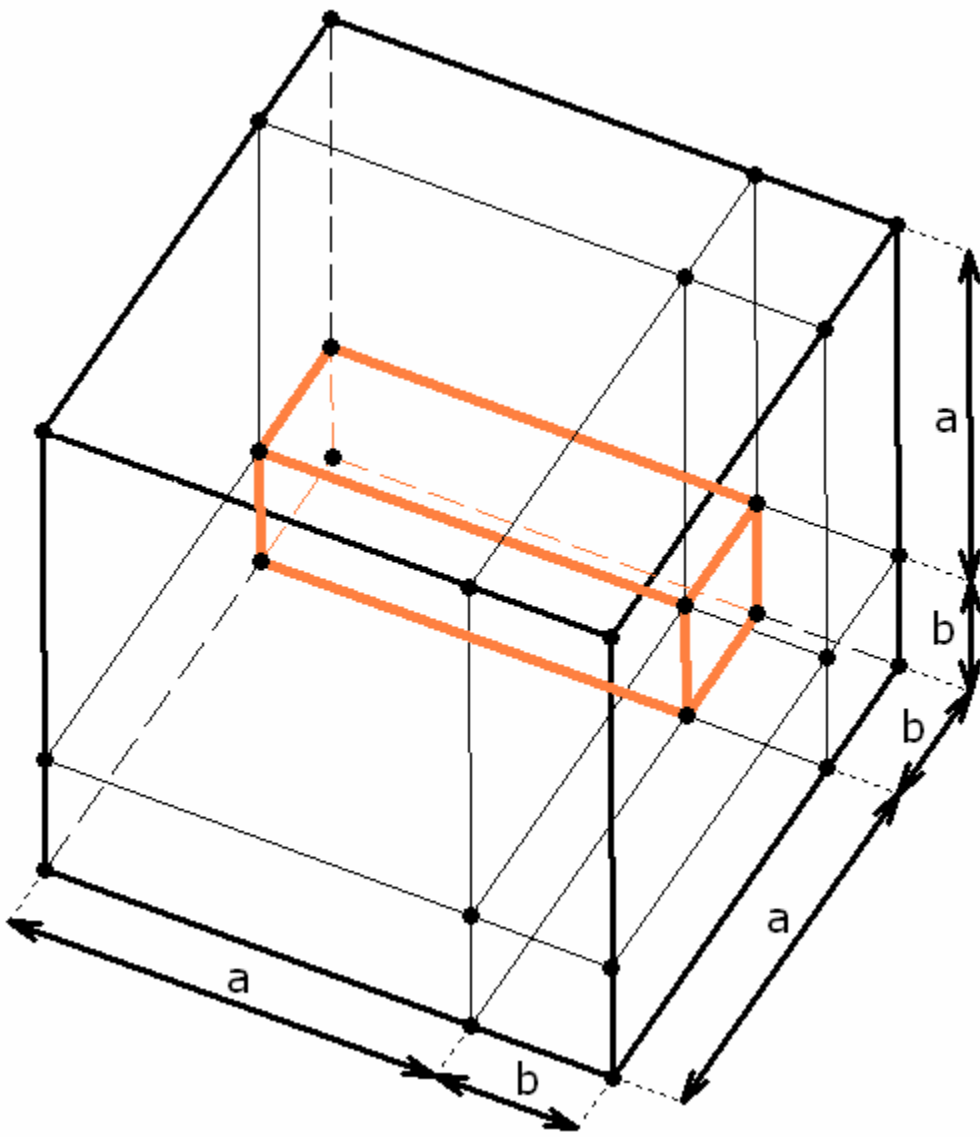

$$+ a^2 b$$

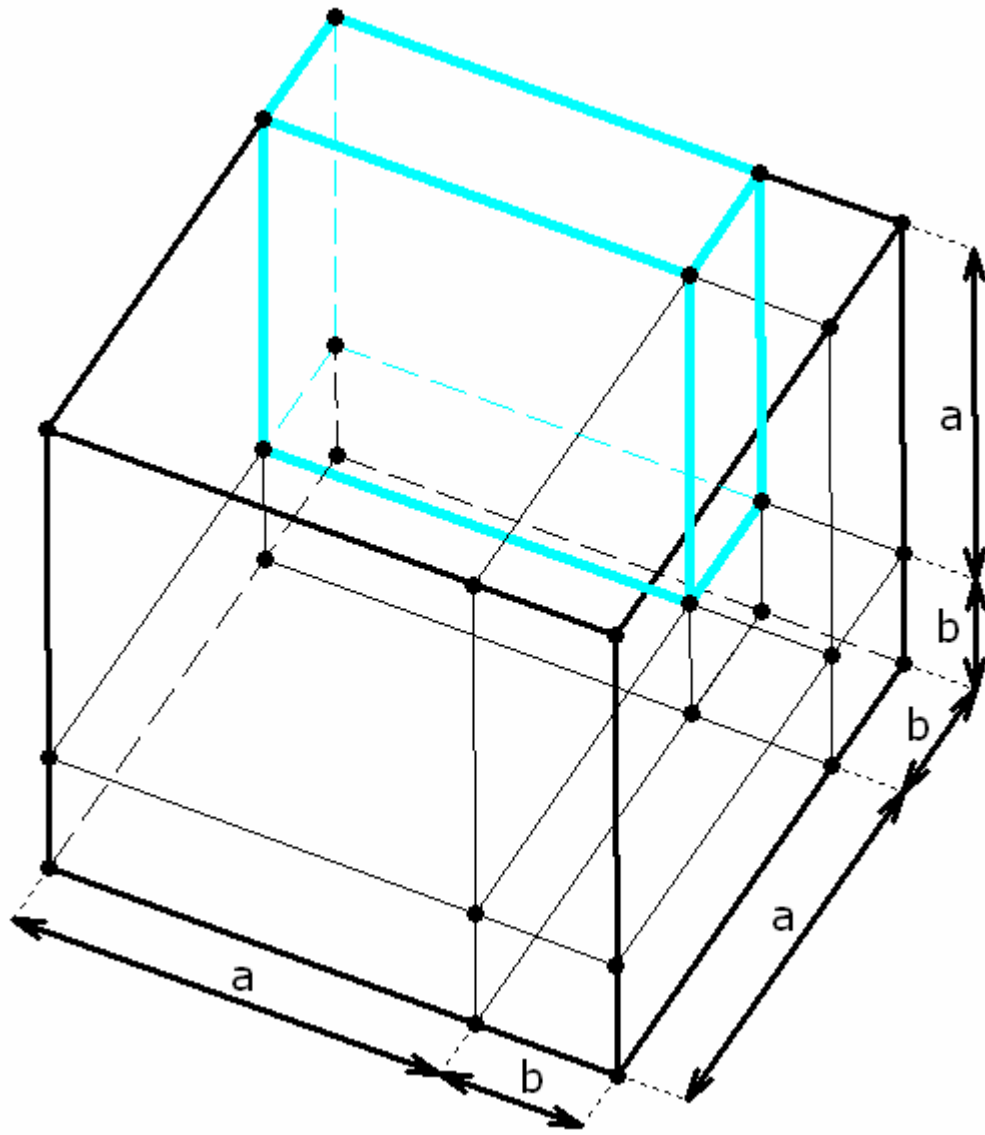

$+ a^2 b$

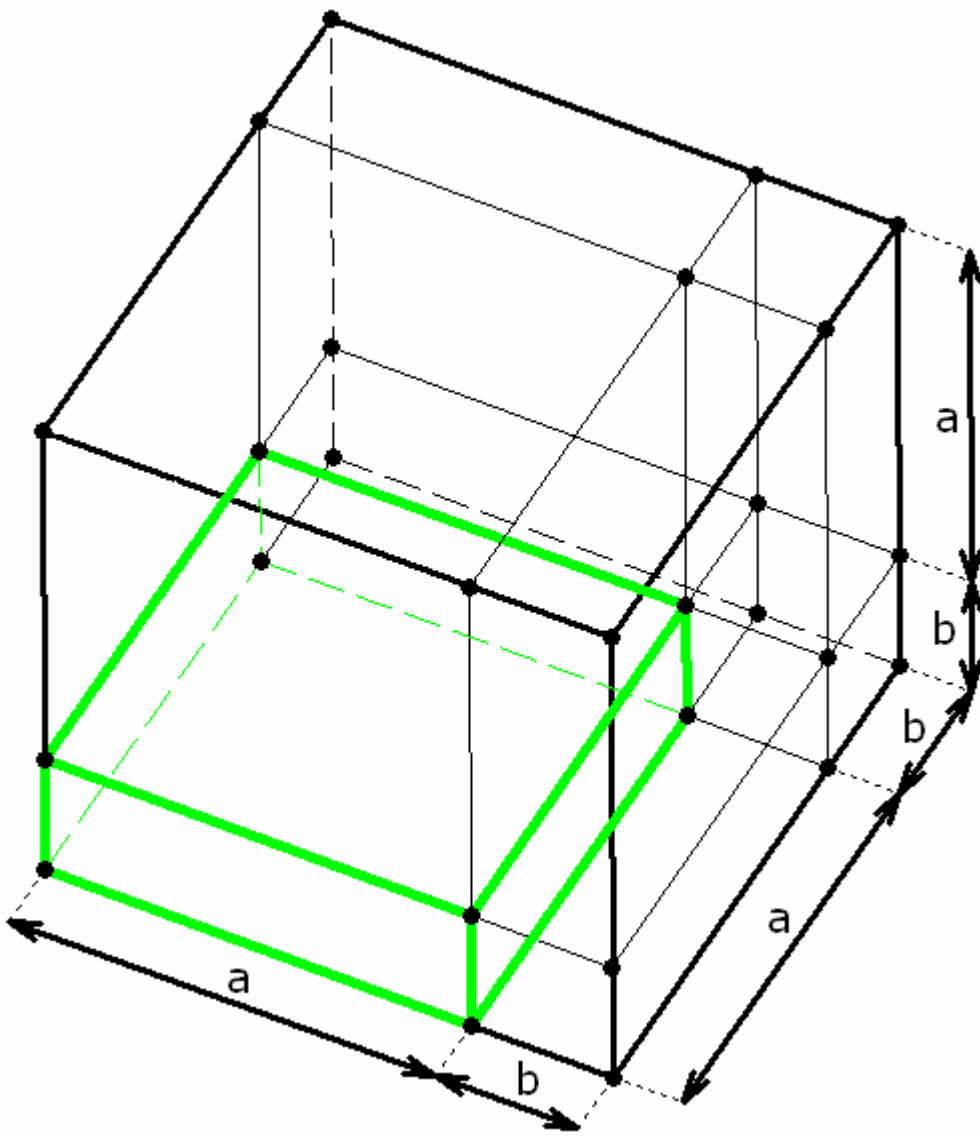

$$+ a^2 b$$

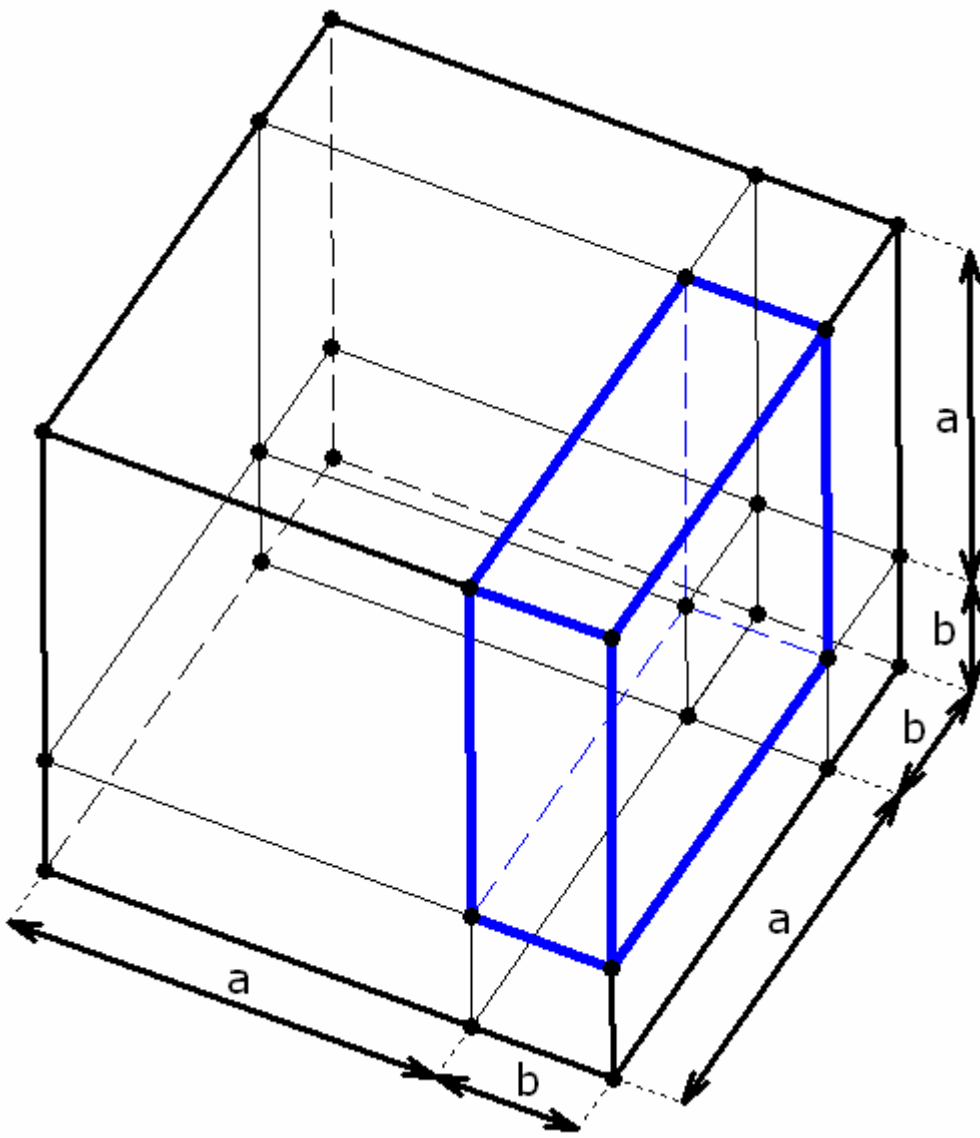

$$+ a^3$$

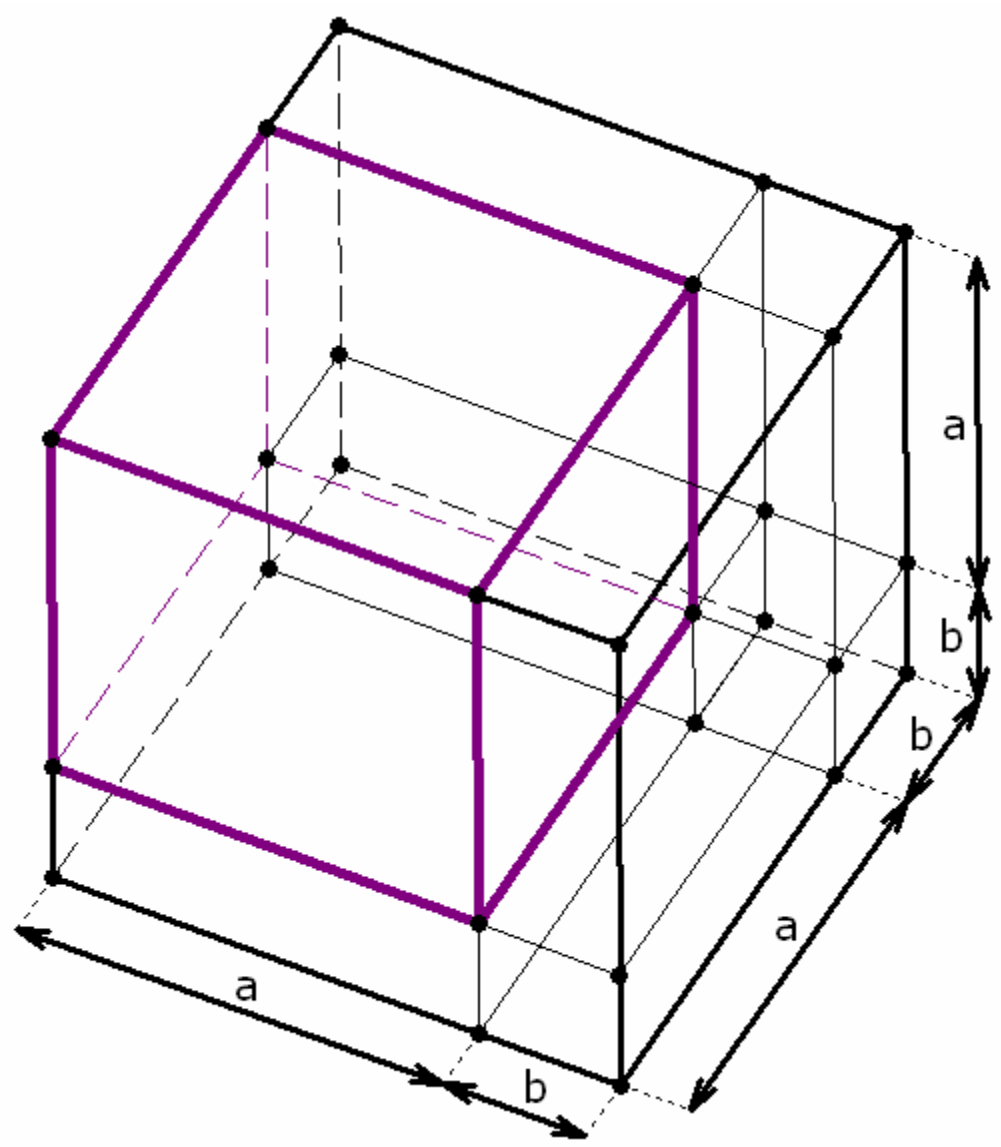

b^3

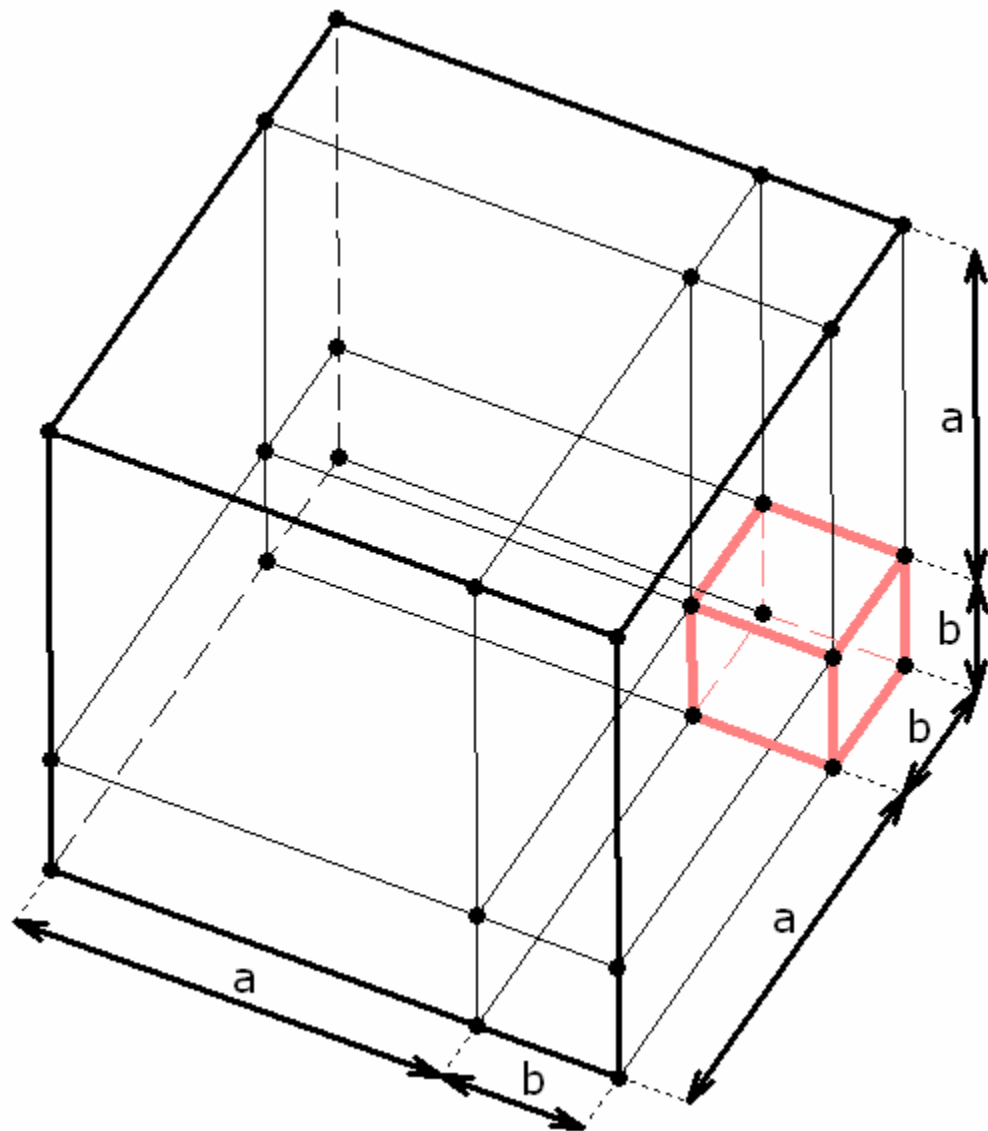

$$+ ab^2$$

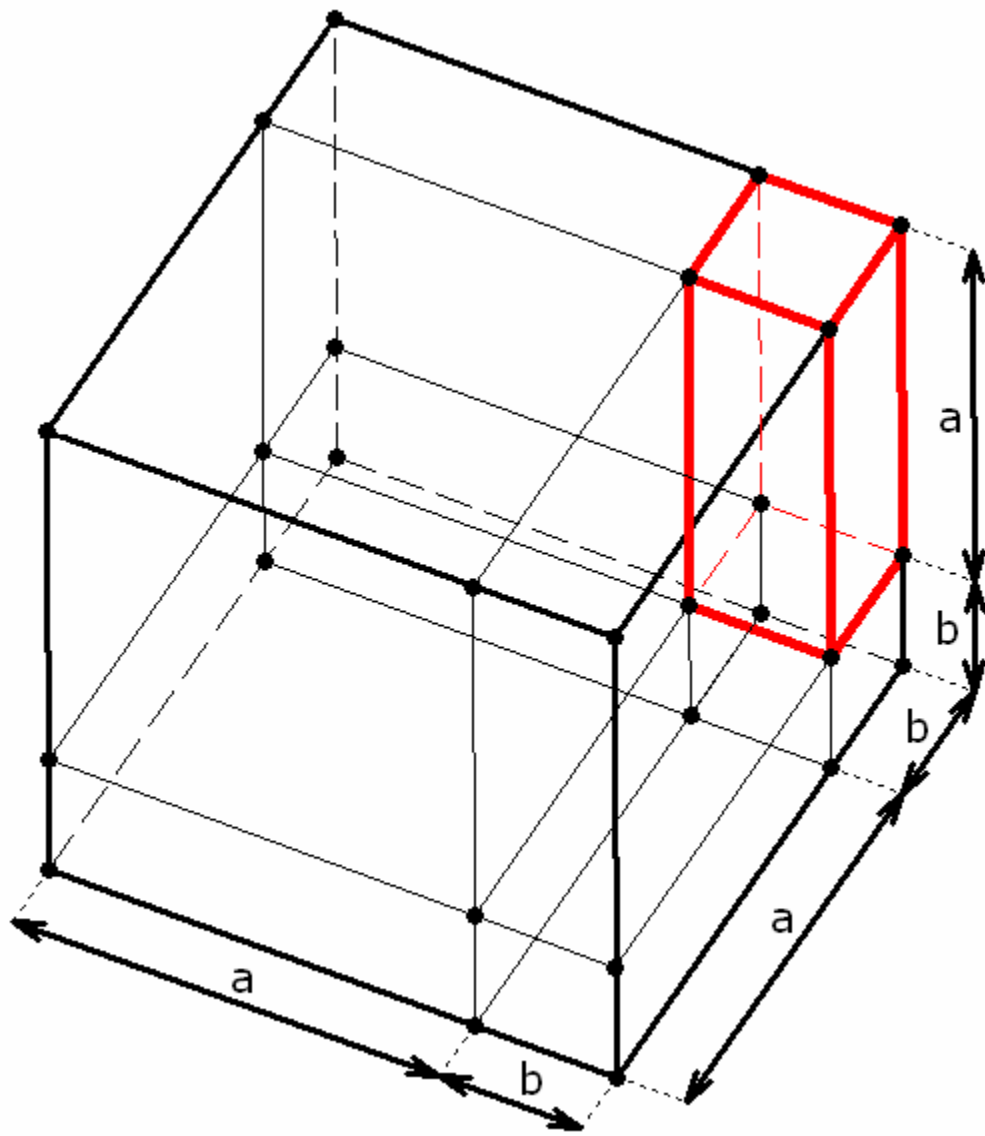

$$+ ab^2$$

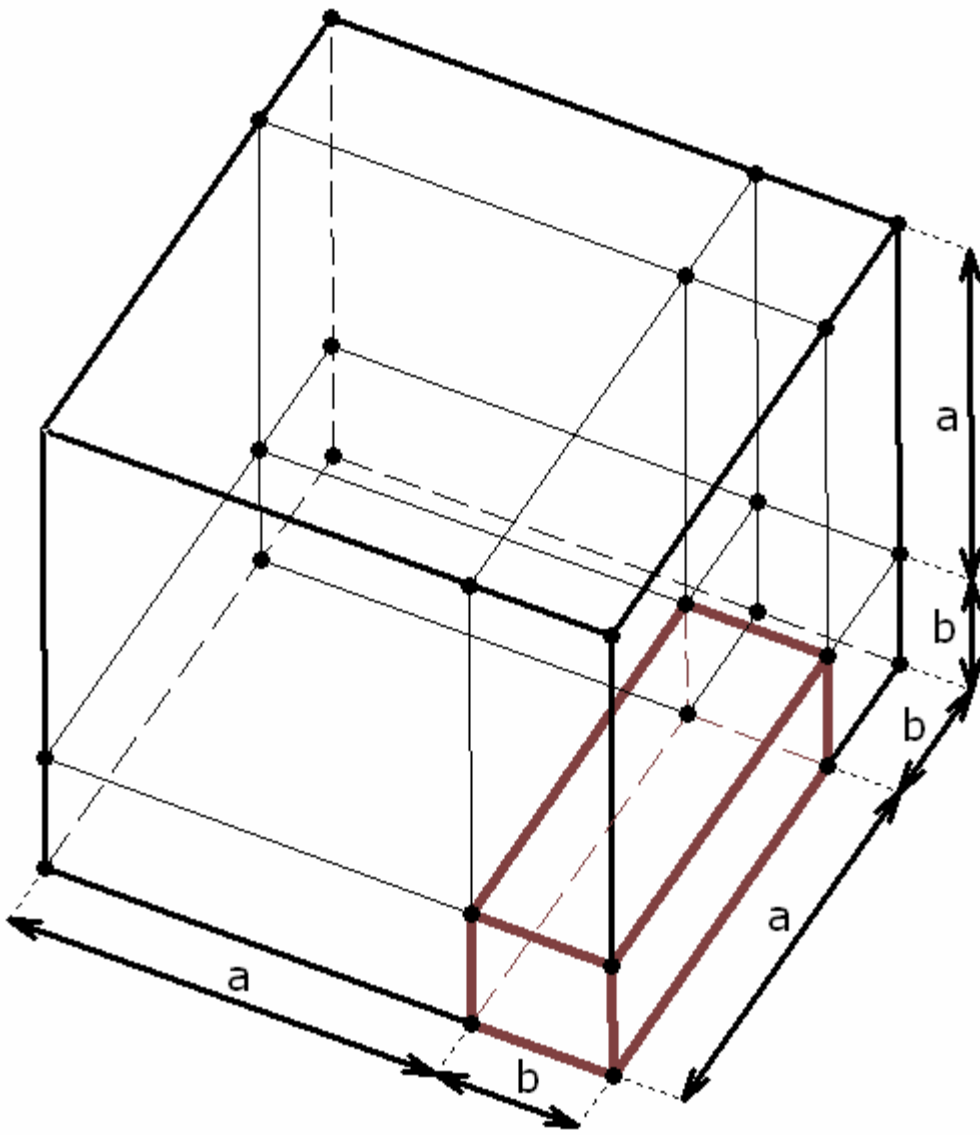

$$+ ab^2$$

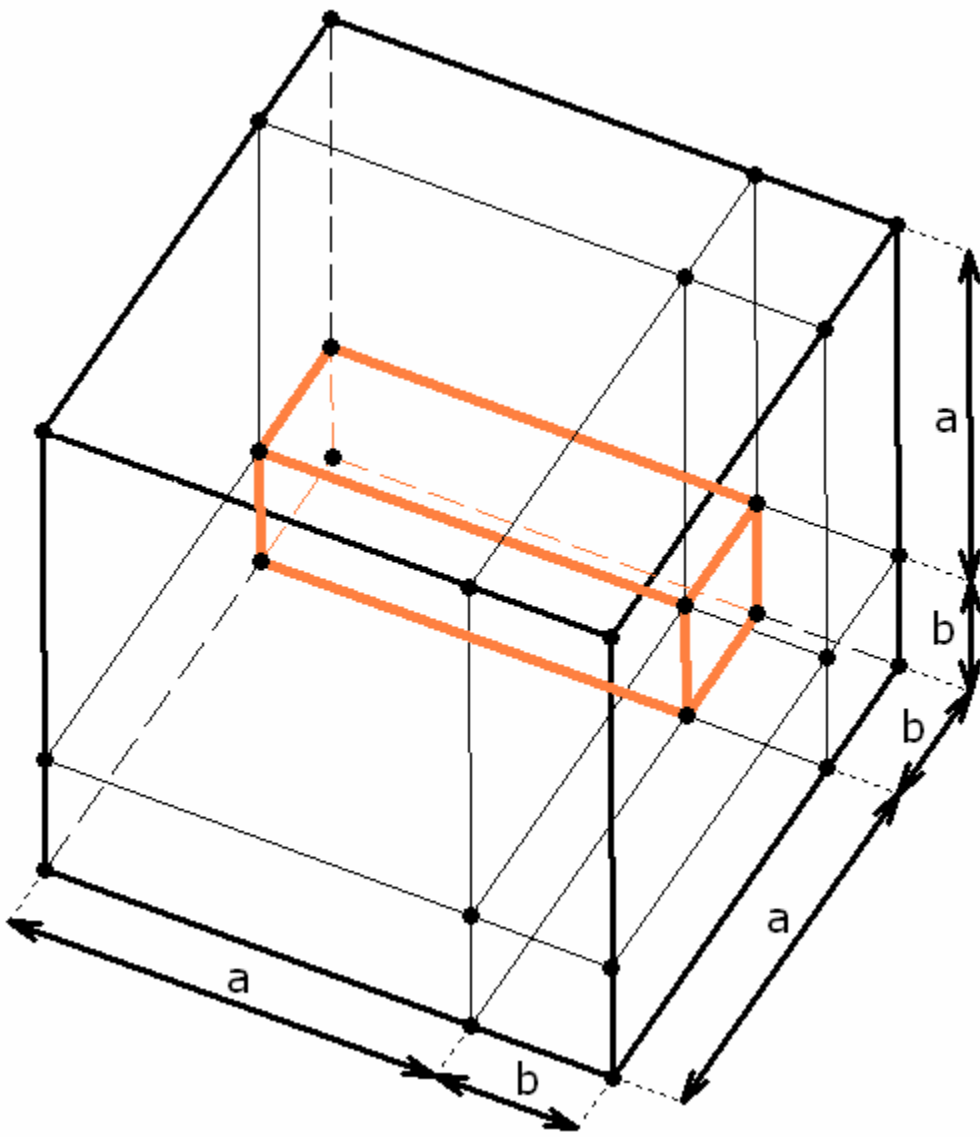

$$+ a^2 b$$

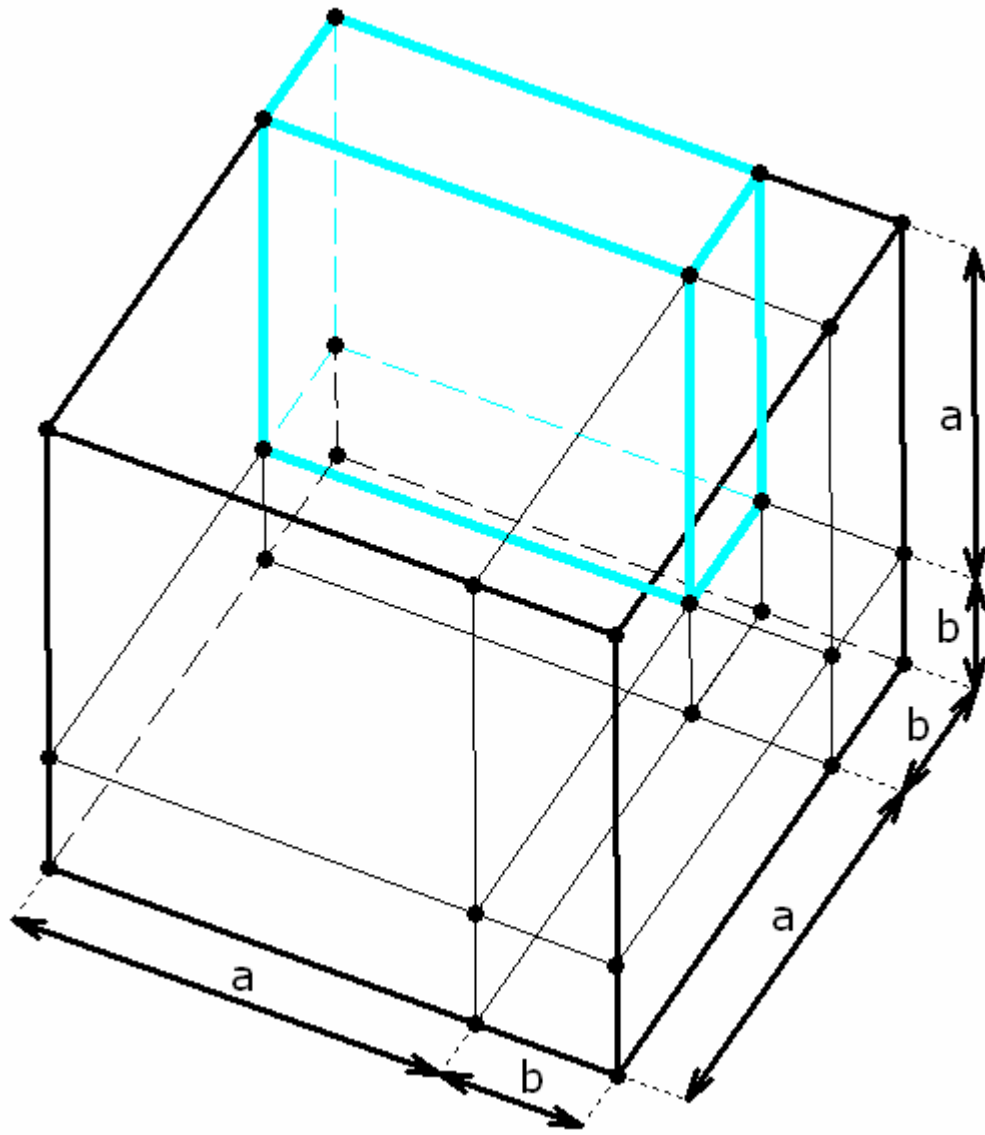

$$+ a^2 b$$

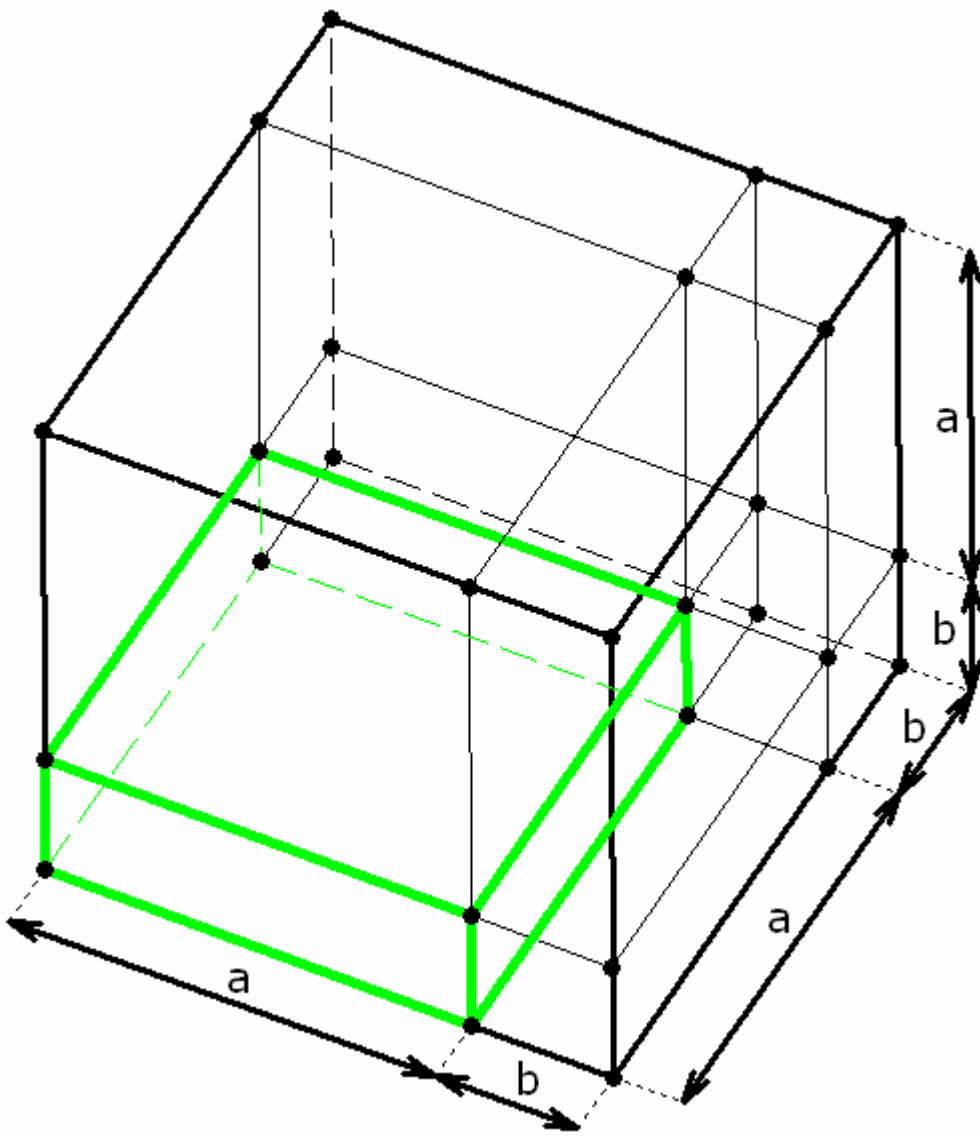

$$+ a^2 b$$

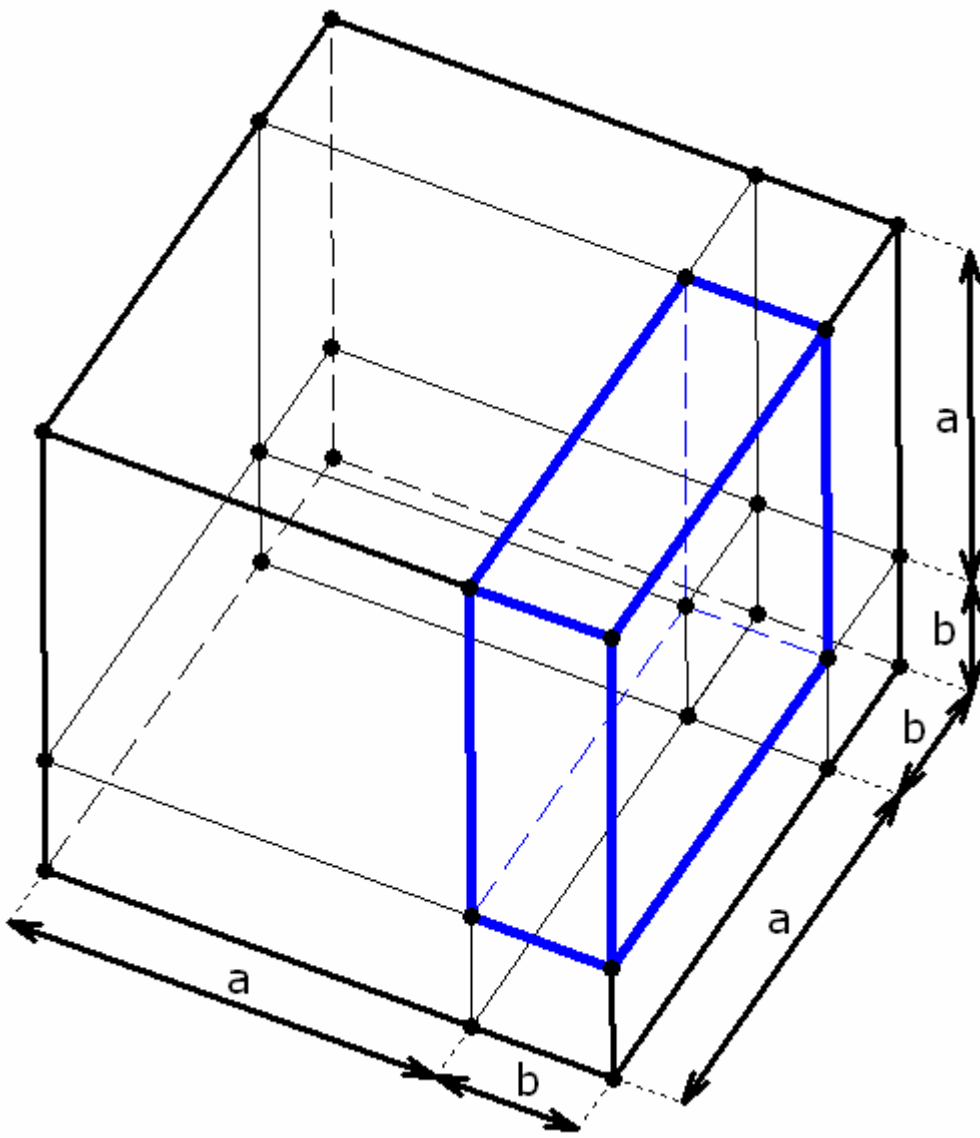

$$+ a^3$$

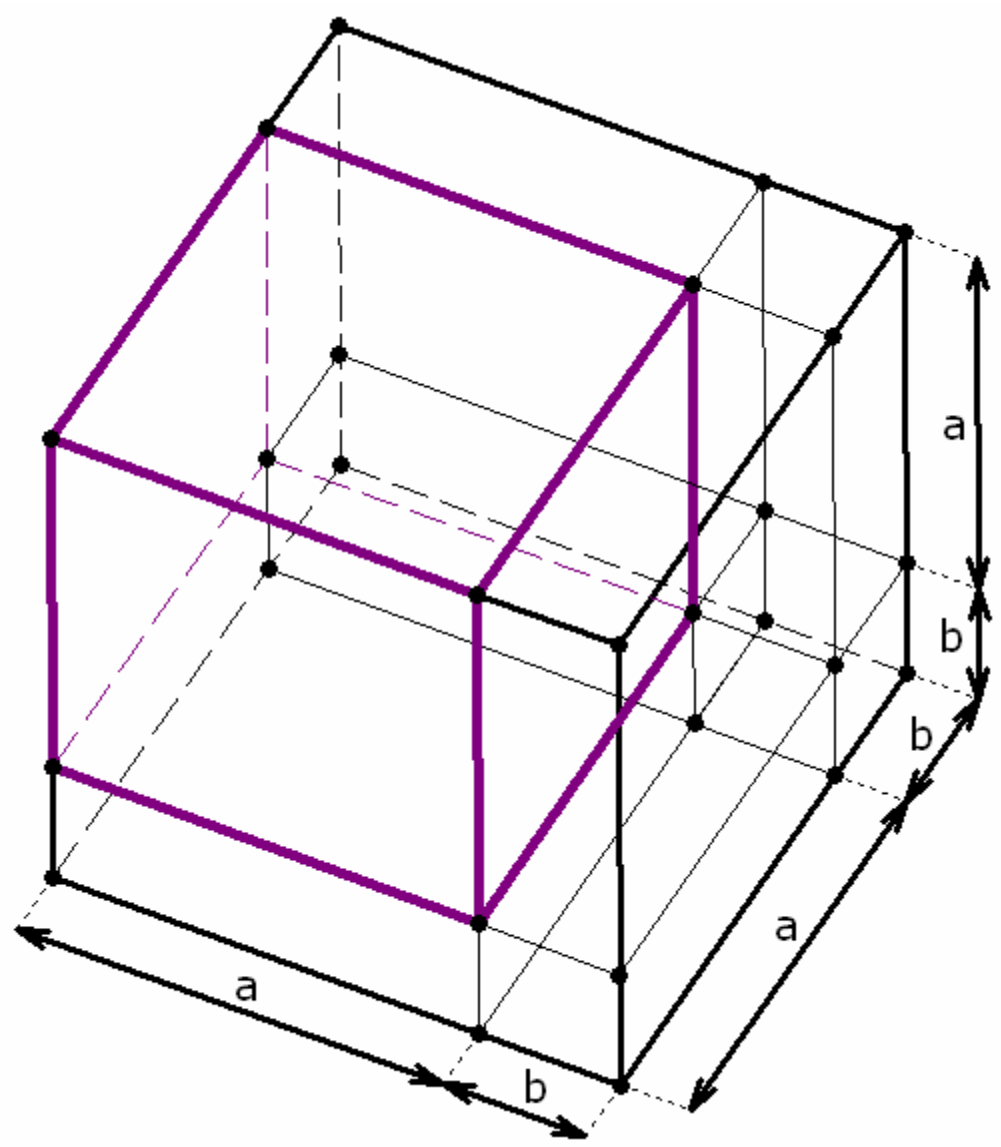

b^3

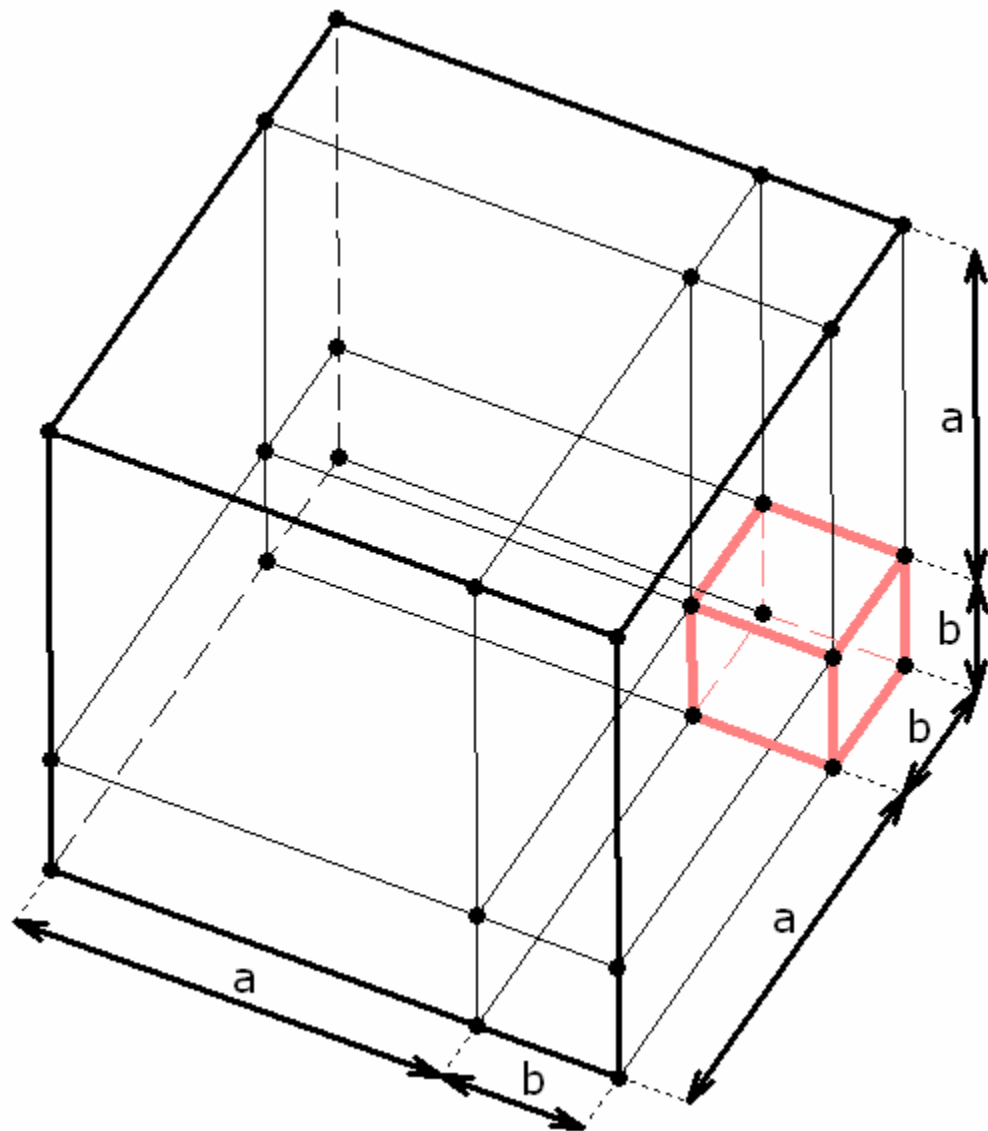

$$+ ab^2$$

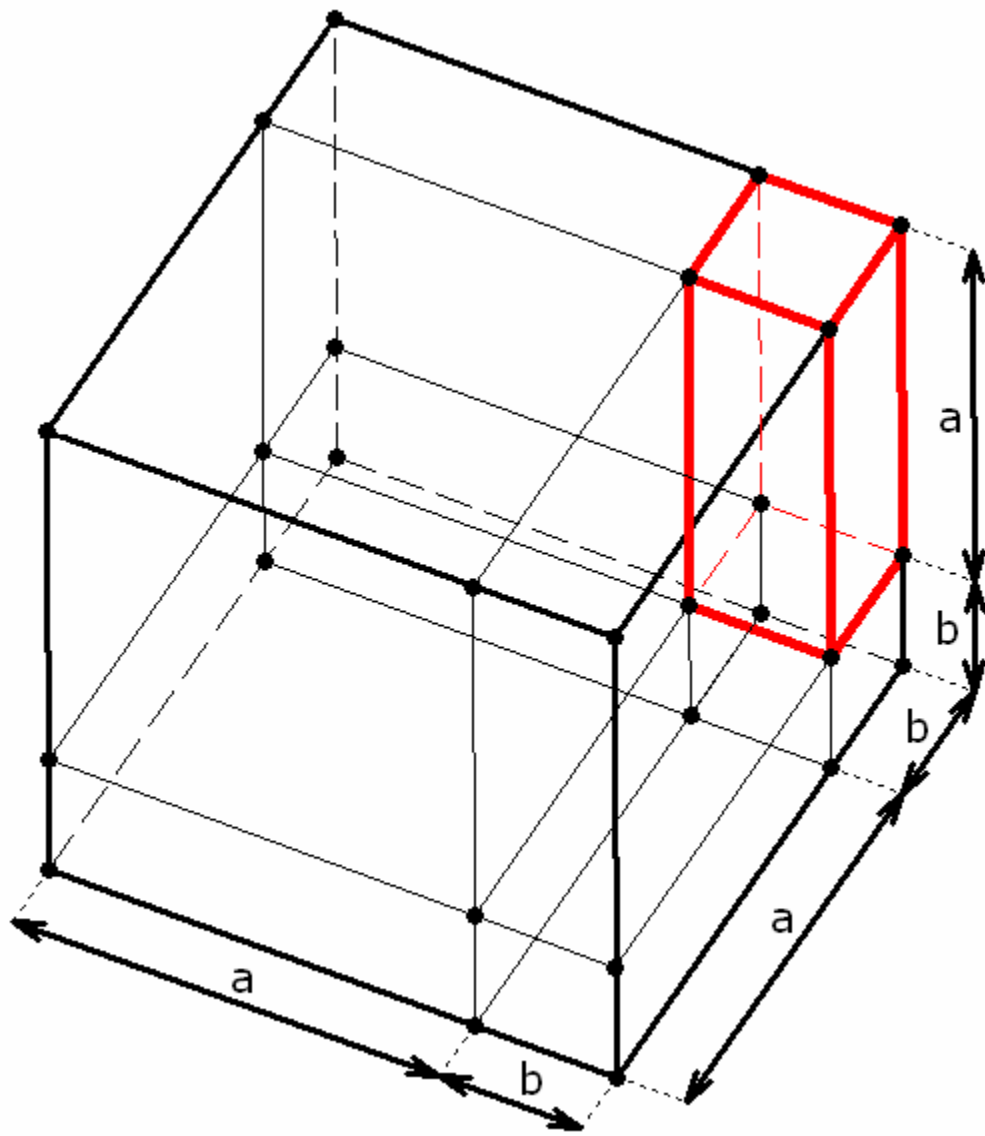

$$+ ab^2$$

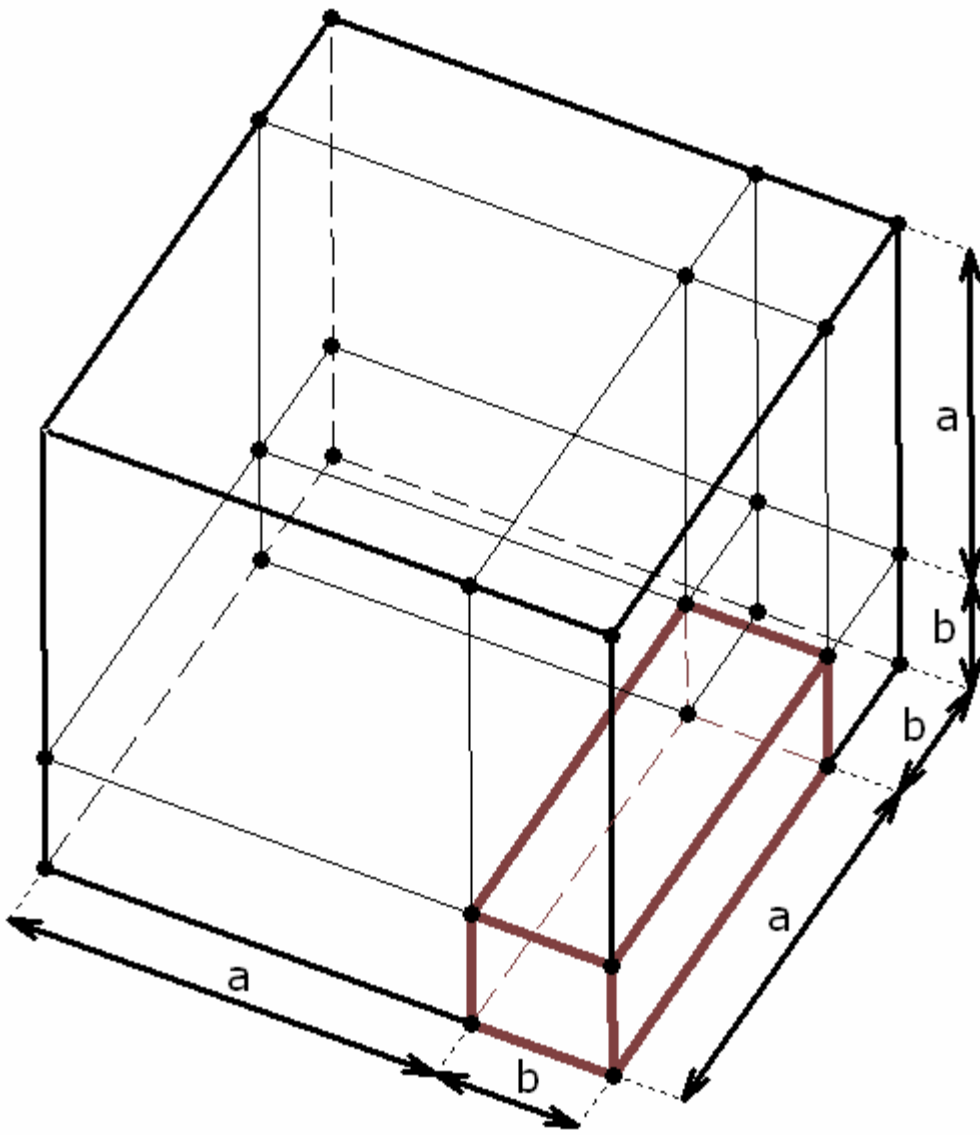

$$+ ab^2$$

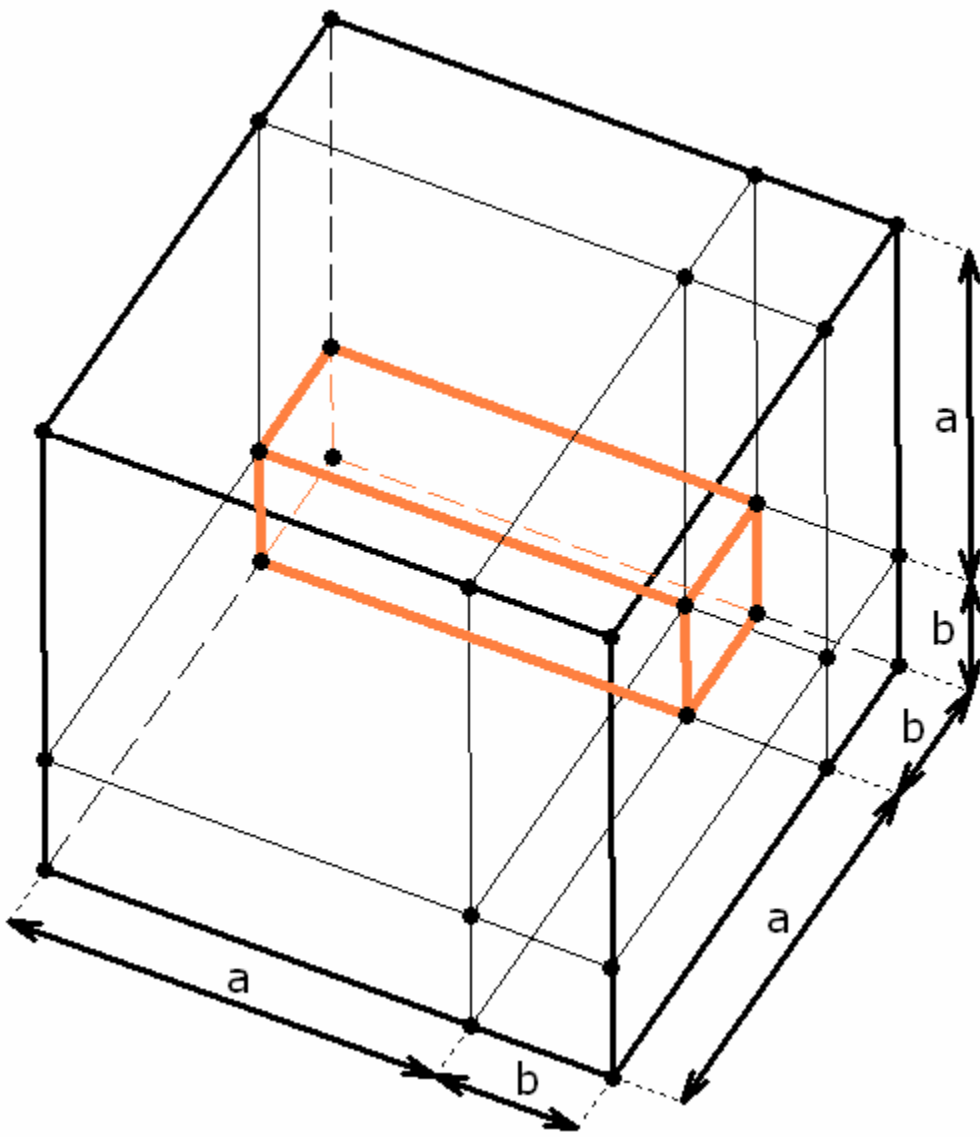

$$+ a^2 b$$

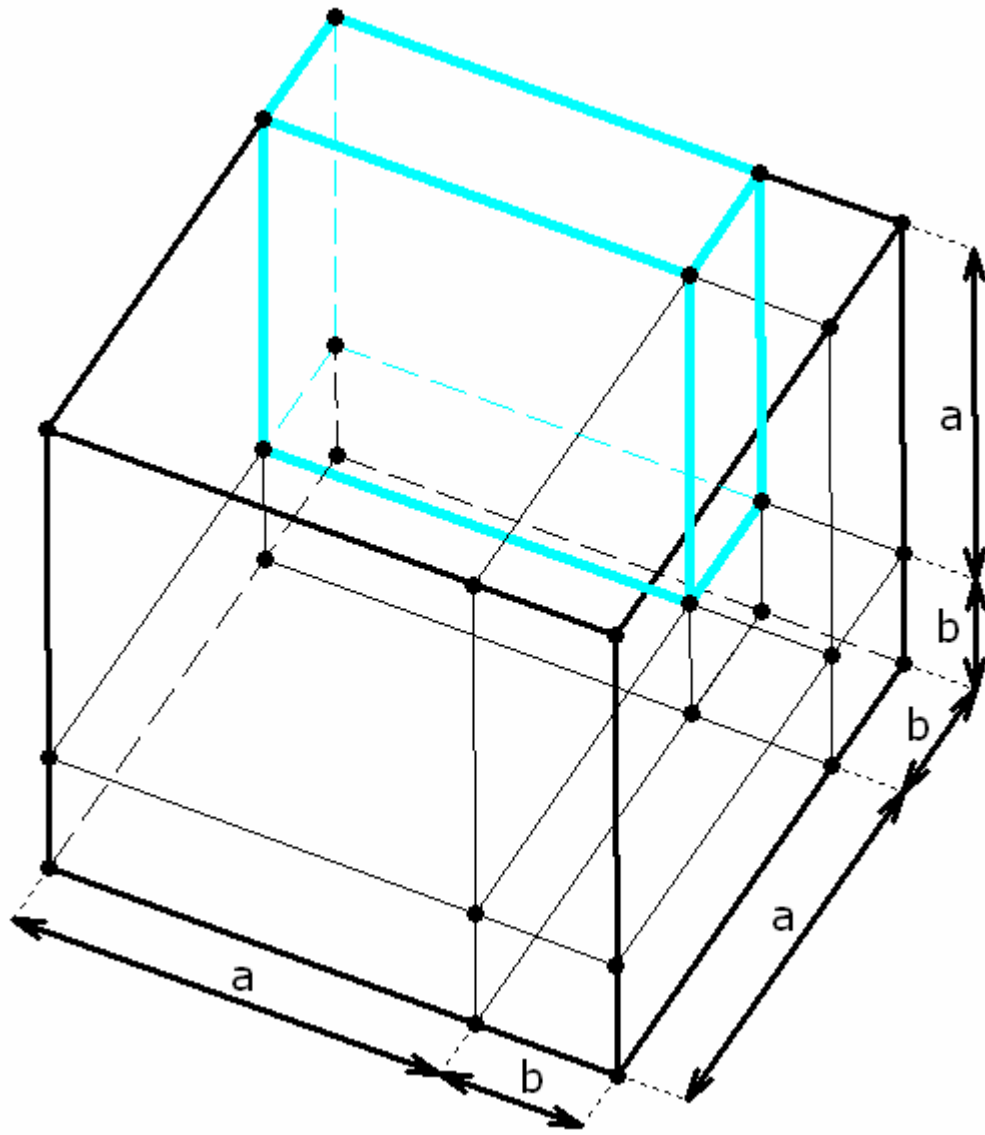

$$+ a^2 b$$

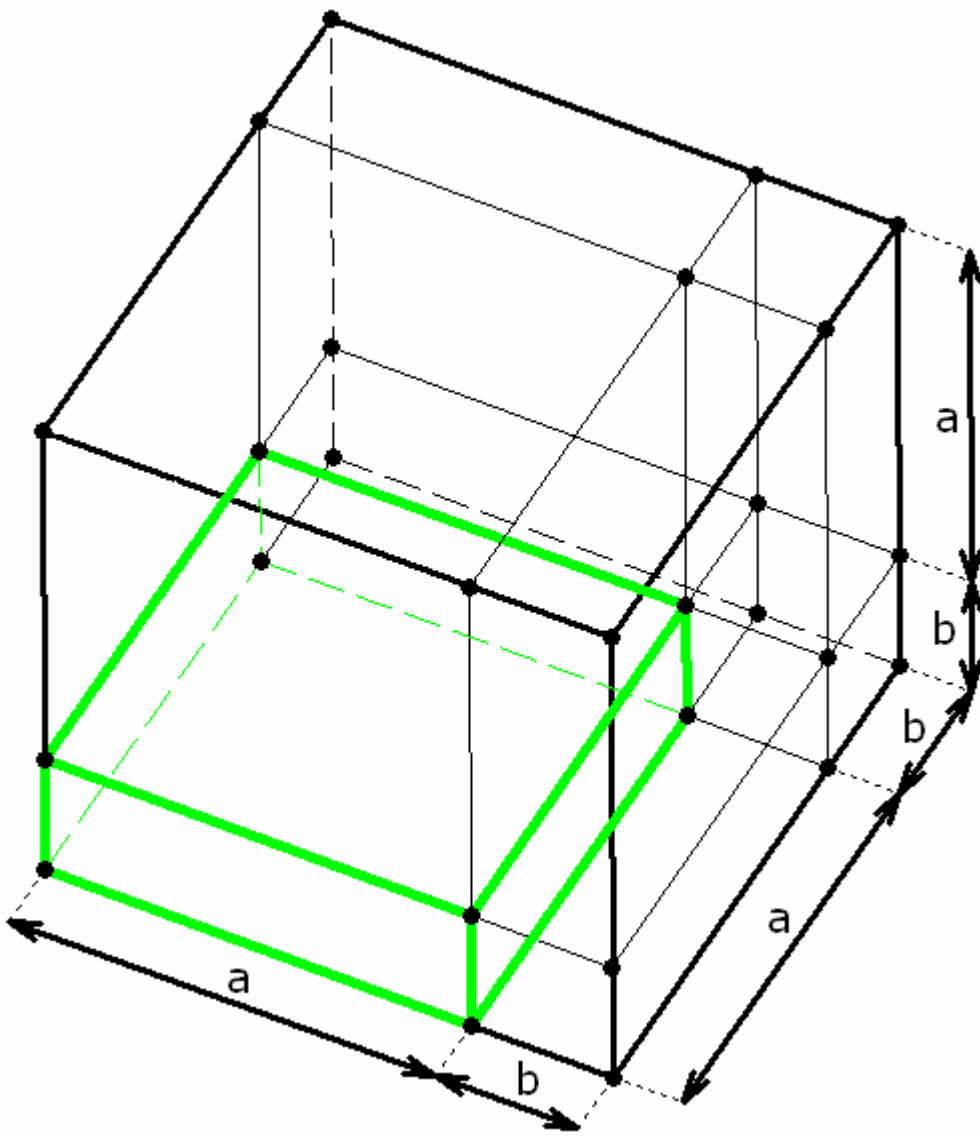

$$+ a^2 b$$

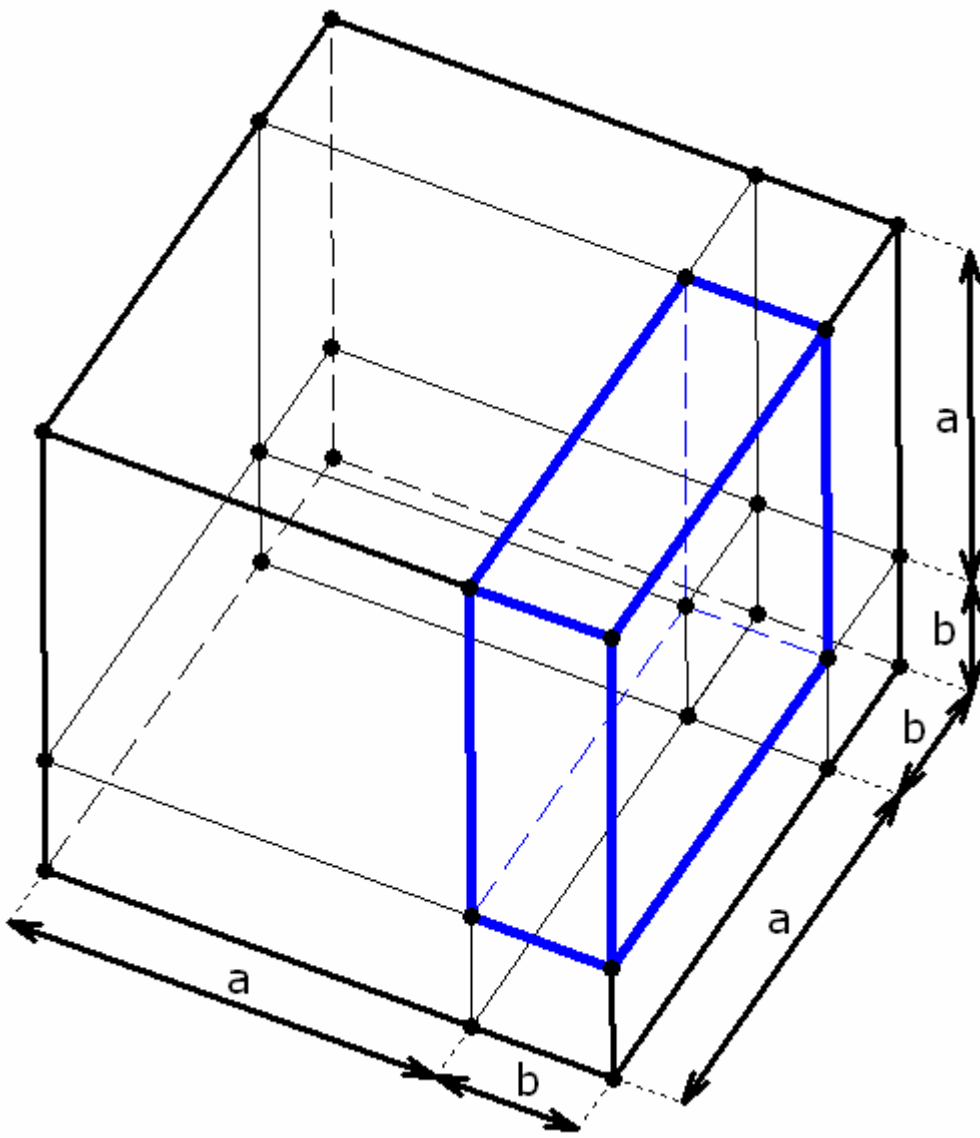

$$+ a^3$$

